

# **ALTUSCN™**

Enterprise KVM Solutions by ATEN

**2 Console 8/16 Port  
Cat 5 High Density KVM Switch  
KH2508 / KH2516  
User Manual**



## FCC Information

This is an FCC Class A product. In a domestic environment this product may cause radio interference in which case the user may be required to take adequate measures.

This equipment has been tested and found to comply with the limits for a Class A digital device, pursuant to Part 15 of the FCC Rules. These limits are designed to provide reasonable protection against harmful interference when the equipment is operated in a commercial environment. This equipment generates, uses and can radiate radio frequency energy and, if not installed and used in accordance with the instruction manual, may cause harmful interference to radio communications. Operation of this equipment in a residential area is likely to cause harmful interference in which case the user will be required to correct the interference at his own expense.

## RoHS

This product is RoHS compliant.

## SJ/T 11364-2006

The following contains information that relates to China.

部件名称	有毒有害物质或元素					
	铅	汞	镉	六价铬	多溴联苯	多溴二苯醚
电器部件	●	○	○	○	○	○
机构部件	○	○	○	○	○	○

- : 表示该有毒有害物质在该部件所有均质材料中的含量均在SJ/T 11363-2006规定的限量要求之下。
- : 表示符合欧盟的豁免条款, 但该有毒有害物质至少在该部件的某一均质材料中的含量超出SJ/T 11363-2006的限量要求。
- ×: 表示该有毒有害物质至少在该部件的某一均质材料中的含量超出SJ/T 11363-2006的限量要求。



## User Information

---

### Online Registration

Be sure to register your product at our online support center:

International		<a href="http://support.aten.com">http://support.aten.com</a>
North America	ATEN TECH	<a href="http://www.aten-usa.com/product_registration">http://www.aten-usa.com/product_registration</a>
	ATEN NJ	<a href="http://support.aten.com">http://support.aten.com</a>

### Telephone Support

For telephone support, call this number:

International		886-2-8692-6959
North America	ATEN TECH	1-888-999-ATEN
	ATEN NJ	1-732-356-1703

### User Notice

All information, documentation, and specifications contained in this manual are subject to change without prior notification by the manufacturer. The manufacturer makes no representations or warranties, either expressed or implied, with respect to the contents hereof and specifically disclaims any warranties as to merchantability or fitness for any particular purpose. Any of the manufacturer's software described in this manual is sold or licensed *as is*. Should the programs prove defective following their purchase, the buyer (and not the manufacturer, its distributor, or its dealer), assumes the entire cost of all necessary servicing, repair and any incidental or consequential damages resulting from any defect in the software.

The manufacturer of this system is not responsible for any radio and/or TV interference caused by unauthorized modifications to this device. It is the responsibility of the user to correct such interference.

The manufacturer is not responsible for any damage incurred in the operation of this system if the correct operational voltage setting was not selected prior to operation. **PLEASE VERIFY THAT THE VOLTAGE SETTING IS CORRECT BEFORE USE.**

## Package Contents

---

The KH2508 / KH2516 package consists of:

- 1 KH2508 / KH2516 Cat 5 KVM Switch
- 1 Power Cord
- 1 Grounding Wire
- 1 Firmware Upgrade Cable
- 1 Rack Mount Kit
- 1 Foot Pad Set (4 pcs.)
- 1 User Manual\*
- 1 Quick Start Guide

Check to make sure that all of the components are present and in good order. If anything is missing, or was damaged in shipping, contact your dealer.

Read this manual thoroughly and follow the installation and operation procedures carefully to prevent any damage to the switch or to any other devices on the KH2508 / KH2516 installation.

---

\* Features may have been added to the KH2508 / KH2516 since this manual was printed. Please visit our website to download the most up to date version of the manual.

---

Copyright © 2008 ATEN® International Co., Ltd.  
Manual Part No. PAPE-0292-AX1G  
F/W Version: 1.1.101  
Manual Date: 2008-10-02

Altusen and the Altusen logo are registered trademarks of ATEN International Co., Ltd. All rights reserved.  
All other brand names and trademarks are the registered property of their respective owners.

# Contents

---

FCC Information . . . . .	ii
SJ/T 11364-2006. . . . .	ii
User Information . . . . .	iii
Online Registration . . . . .	iii
Telephone Support . . . . .	iii
User Notice . . . . .	iii
Package Contents. . . . .	iv
About This Manual . . . . .	viii
Overview . . . . .	viii
Conventions . . . . .	ix
Product Information. . . . .	ix

## **Chapter 1.**

### **Introduction**

Overview . . . . .	1
Features . . . . .	3
Requirements . . . . .	4
Consoles . . . . .	4
Computers. . . . .	4
KVM Adapter Cables. . . . .	4
Other Cables . . . . .	5
Operating Systems . . . . .	5
Components . . . . .	6
Front View . . . . .	6
Rear View . . . . .	8
Local Console Connection . . . . .	9

## **Chapter 2.**

### **Hardware Setup**

Overview . . . . .	11
Before you Begin. . . . .	11
Stacking and Rack Mounting . . . . .	12
Stacking. . . . .	12
Rack Mounting – Front . . . . .	13
Rack Mounting – Rear. . . . .	15
Grounding . . . . .	16
Single Level Installation . . . . .	17
KVM Adapter Cable Installation Diagrams . . . . .	19
Cascaded Installations . . . . .	20
Cascading KH2508 / KH2516 Cat 5 KVM Switches . . . . .	21

**Chapter 3.****Basic Operation**

Hot Plugging . . . . .	25
Changing Cascaded Switch Positions . . . . .	25
Hot Plugging Console Ports . . . . .	25
Powering Off and Restarting. . . . .	25
Port Selection . . . . .	25

**Chapter 4.****OSD Operation**

OSD Overview . . . . .	27
The Main Page . . . . .	29
Quick View Ports. . . . .	30
The List Function. . . . .	31
Port Names . . . . .	33
Port Operation . . . . .	36
The OSD Toolbar . . . . .	36
The Toolbar Icons . . . . .	37
Recalling the OSD. . . . .	38
OSD Hotkey Summary Table . . . . .	38
Port Operation Hotkey Overview. . . . .	38
Auto Scanning. . . . .	39
Setting the Scan Interval . . . . .	39
Invoking Auto Scan . . . . .	39
Pausing Auto Scan . . . . .	39
Exiting Auto Scan Mode . . . . .	39
Skip Mode . . . . .	40
The Configuration Page . . . . .	40
The Administration Page . . . . .	42
General . . . . .	42
User Management . . . . .	43
Port Access . . . . .	45
System . . . . .	46
Configuration. . . . .	46
Adapter Cable . . . . .	47
Upgrade Failed . . . . .	51
Attributes . . . . .	52
Changing Attributes. . . . .	53
Operation Mode Attributes . . . . .	54
Miscellaneous . . . . .	54
Date/Time . . . . .	55
The Log Page . . . . .	56

---

**Chapter 5.****The Firmware Upgrade Utility**

Introduction . . . . .	57
Downloading the Firmware Upgrade Package . . . . .	57
Preparing to Upgrade the Firmware . . . . .	58
Performing the Upgrade . . . . .	59
Upgrade Successful . . . . .	63
Stopping the Firmware Upgrade . . . . .	64
Upgrading Adapter Cables . . . . .	64
Upgrade Failed . . . . .	65
Firmware Upgrade Recovery . . . . .	65

**Chapter 6.****Keyboard Emulation**

Mac Keyboard . . . . .	67
Sun Keyboard . . . . .	68

**Appendix**

Safety Instructions . . . . .	69
General . . . . .	69
Rack Mounting . . . . .	71
Technical Support . . . . .	72
International . . . . .	72
North America . . . . .	72
Specifications . . . . .	73
OSD Factory Default Settings . . . . .	74
Troubleshooting . . . . .	75
Overview . . . . .	75
General . . . . .	75
Sun Systems . . . . .	77
Restoring Original Factory Default Settings . . . . .	78
Entering the ok Prompt (Sun Solaris) . . . . .	79
Supported KVM Switches . . . . .	79
Limited Warranty . . . . .	80

## About This Manual

---

This user manual is provided to help you get the most from your KH2508 / KH2516 system. It covers all aspects of installation, configuration and operation. An overview of the information found in the manual is provided below.

### Overview

**Chapter 1, Introduction**, introduces you to the KH2508 / KH2516 system. Its purpose, features, and benefits are presented, and its front and back panel components are described.

**Chapter 2, Hardware Setup**, provides step-by-step instructions for setting up your installation, and explains some basic operating procedures.

**Chapter 3, Basic Operation**, explains the fundamental concepts involved in operating the KH2508 / KH2516.

**Chapter 4, OSD Operation**, provides detailed information for configuring and controlling your installation using the KH2508 / KH2516's intuitive, mouse-driven on-screen display (OSD) menus.

**Chapter 5, The Firmware Upgrade Utility**, explains how to upgrade the KH2508 / KH2516's firmware with the latest available versions.

**Chapter 6, Keyboard Emulation**, lists the keys for a PC-compatible keyboard to emulate the functions of the Mac and Sun keyboards.

**An Appendix** at the end of the manual provides technical and troubleshooting information.



## Conventions

This manual uses the following conventions:

- Monospaced      Indicates text that you should key in.
- [ ]                Indicates keys you should press. For example, **[Enter]** means to press the **Enter** key. If keys need to be chorded, they appear together in the same bracket with a plus sign between them: **[Ctrl+Alt]**.
1.                 Numbered lists represent procedures with sequential steps.
- ◆                 Bullet lists provide information, but do not involve sequential steps.
- Indicates selecting the option (on a menu or dialog box, for example), that comes next. For example, Start → Run means to open the *Start* menu, and then select *Run*.
-                 Indicates critical information.

## Product Information

For information about all ALTUSEN products and how they can help you connect without limits, visit ALTUSEN on the Web or contact an ALTUSEN Authorized Reseller. Visit ALTUSEN on the Web for a list of locations and telephone numbers:

International		<a href="http://www.aten.com">http://www.aten.com</a>
North America	ATEN TECH	<a href="http://www.aten-usa.com">http://www.aten-usa.com</a>
	ATEN NJ	<a href="http://www.aten.com">http://www.aten.com</a>

This Page Intentionally Left Blank

# Chapter 1

## Introduction

### Overview

---

The KH2508 / KH2516 Cat 5 High Density KVM Switches give IT administrators advanced control of multiple computers. Operators working at up to two keyboard, monitor, and mouse (KVM) consoles can independently and simultaneously take direct control of up to 8 or 16 computers in a single-level installation, or up to 512 or 4096 KVM ports in a full three-level cascaded switch installation. Cascading is achieved via dedicated RJ-45 cascade ports and Cat 5e cabling.

The two KVM consoles belonging to the first-level KH2508 / KH2516 are able to access all the computers on the installation – those that are directly connected to the switch, as well as those that are cascaded. Where applicable, one KVM console belonging to each cascaded KH2508 / KH2516 can access the computers on the same, or lower level.

The KH2508 / KH2516 feature RJ-45 connectors and Cat 5e cable to link to the computers. 1280 x 1024 @ 75Hz video signals can travel up to 40 m (130 feet), eliminating the need for KVM extenders. Utilizing PS/2 and USB KVM adapter cables for the final linkup, the KH2508 / KH2516 permits any combination of PCs, Macs, Sun computers, and serial devices to coexist on the installation. Additionally, the use of RJ-45 connectors saves precious IT real estate by allowing 8 or 16 KVM ports to reside in a single 1U housing.

Access to any computer connected to the installation is easily accomplished by means of mouse-driven on-screen display (OSD) menus. A convenient *Auto Scan* feature also permits automatic scanning and monitoring of the activities of computers running on the installation one-by-one.

Setup is fast and easy – plugging cables into their appropriate ports is all that is entailed. Because the KH2508 / KH2516 intercepts keyboard and mouse input directly, there is no software to configure, and no need to get involved in complex installation routines, or be concerned with incompatibility problems.

Your KH2508 / KH2516 investment is protected by a Firmware Upgrade Utility. You can stay current with the latest improvements in functionality by using the Firmware Upgrade Utility to upgrade your installation. Check our website frequently to download the latest updates to the KH2508 / KH2516 Firmware Upgrade Utility.

There is no better way to save time and money than with a KH2508 / KH2516 installation. By allowing two consoles to manage up to 4096 computers, a KH2508 / KH2516 installation: (1) eliminates the expense of having to purchase a separate keyboard, monitor, and mouse for each; (2) saves all the space those extra components would take up; (3) saves on energy costs; and (4) eliminates the inconvenience and wasted effort involved in constantly moving from one computer to another.

With their advanced security features, the KH2508 / KH2516 Cat 5 High Density KVM Switches provide the fastest, most reliable, most cost effective way to access and manage multiple computer installations.

---

## Features

---

- ◆ Two KVM consoles independently and simultaneously control up to 8 or 16 directly connected computers
- ◆ Cascade up to 3 levels of KH2508 or KH2516 switches to support up to 512 or 4096 computers
- ◆ Superior video resolution – 1280 x 1024 @ 75 Hz up to 40 m; 1600 x 1200 @ 60 Hz up to 30 m
- ◆ Multiplatform support: PC, Mac, Sun, and serial
- ◆ Backup and restore configuration settings to an external flash drive to simplify installation on multiple switches, or for disaster recovery
- ◆ No software to install – convenient computer selection via graphical on-screen display (OSD) menus
- ◆ Supports two-level user access control (administrator and user)
- ◆ Supports up to 96 user accounts
- ◆ Configure port access rights for users on a port-by-port basis
- ◆ Diversified port operation mode enables flexible computer management – *Occupy*, *Exclusive* and *Share* modes<sup>1</sup>
- ◆ OSD port list automatically expands when stations are added
- ◆ Port names are automatically reconfigured when the station/computer sequence is changed
- ◆ OSD screen automatically adjusts to resolution changes
- ◆ Auto Scan mode enables continuous monitoring of user-selected computers
- ◆ User activity log support
- ◆ Console conversion – any type of KVM console can control any type of computer; mixed combinations (PS/2 & USB) supported on both the KVM console and computer sides
- ◆ USB / PS/2 keyboard and mouse emulation – computers boot even when the KVM console focus is elsewhere
- ◆ Hot pluggable – add or remove components without having to power off the KVM switch
- ◆ Free lifetime firmware upgrades
- ◆ Effortlessly upgrade an entire installation – automatically upgrade all cascaded switches and adapter cables directly from the root station
- ◆ Compact design – rack mounts in only 1U of rack space

---

1. *Occupy*, *Exclusive* and *Share* modes supported on the first level switch only. Cascaded switches operate under *Cascade* mode. See page 46.

## Requirements

---

### Consoles

The following hardware components are required for each KVM console:

- ◆ A VGA, SVGA, or multisync monitor capable of displaying the highest resolution provided by any computer in the installation
- ◆ Keyboard and mouse (PS/2 or USB)

### Computers

The following hardware components are required for each computer:

- ◆ A VGA, SVGA, or multisync video graphics card with an HDB-15 port; or, for Sun legacy systems, a Sun 13W3 video port
- ◆ PS/2 mouse and keyboard ports (6-pin Mini-DIN), or at least one USB port; or, for Sun legacy systems, a Sun style keyboard port (8-pin Mini-DIN)

### KVM Adapter Cables

KVM adapter cables together with Cat 5e cabling connect multiplatform computers (PS/2, USB, Sun, Mac, and serial devices) to the KH2508 / KH2516. The KVM adapter cables currently available are listed in the table below. Contact your dealer for details.

Function		Model Number
KVM adapter cables	For PS/2 computers	KA9520
	For USB computers	KA9570
	For Sun legacy systems	KA9130
	For Sun USB systems	KA9131 KA9170
	For serial devices	KA9140

## **Other Cables**

The following cables are also required for use with the KH2508 / KH2516.

<b>Function</b>	<b>Type</b>
KVM adapter cable to KH2508 / KH2516 (see page 19)	Cat 5e cable
Cascading (see page 20)	Cat 5e cable

## **Operating Systems**

Supported operating systems are shown in the table, below.

<b>OS</b>		<b>Version</b>
Windows		ME, NT, 2000 and higher
Linux	RedHat	6.0 and higher
	SuSE	8.2 and higher
	Mandriva (Mandrake)	9.0 and higher
UNIX	AIX	4.3 and higher
	FreeBSD	3.51 and higher
	Sun	Solaris 8 and higher
Novell	Netware	5.0 and higher
Mac		8.6 and higher
OS/2		Warp and higher

# Components

---

## Front View

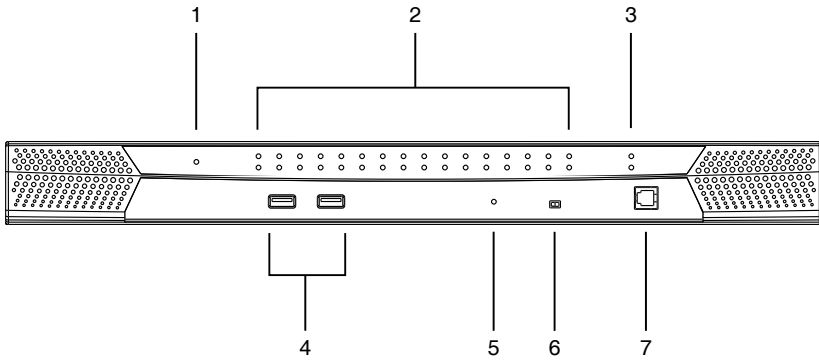

---

**Note:** The KH2516 is pictured above. The KH2508 front panel is the same as that of the KH2516, except that it has 8 KVM port LEDs instead of 16.

---



No.	Component	Description
1	Power LED	Lights (blue) to indicate that the unit is receiving power.
2	Port LEDs	<ul style="list-style-type: none"><li>◆ A green LED indicates that a computer is connected to the corresponding port.</li><li>◆ A flashing green LED indicates a connection to a cascaded child KVM switch.</li><li>◆ A red LED indicates that the computer connected to the corresponding port has focus.</li><li>◆ A flashing red LED indicates that the computer connected to the corresponding cascaded port has focus.</li></ul>
3	Cascade Port LEDs	A flashing green LED indicates a connection between cascaded parent and child KVM switches.
4	USB Ports	Connect USB flash drives to these ports to backup and restore configuration settings for consoles 1 and 2. See <i>Configuration</i> , page 46.
5	Reset Button	<p>Pressing in this button performs a system reset. When the system is reset, the KH2508 / KH2516 beeps, and then the KVM port LEDs flash in succession until the reset is completed. After the reset is completed you can login again.</p> <p><b>Note:</b> This button is semi-recessed and must be pushed with a small object, such as the end of a paper clip or a ballpoint pen.</p>
6	Firmware Upgrade Recovery Switch	During normal operation and while performing a firmware upgrade, this switch should be in the NORMAL position. If a firmware upgrade operation does not complete successfully, this switch is used to perform a firmware upgrade recovery. See <i>Firmware Upgrade Recovery</i> , page 65, for details.
7	Firmware Upgrade Port	The firmware upgrade cable that transfers the firmware upgrade data from the administrator's computer to the KH2508 / KH2516, plugs into this RJ-11 connector.

## Rear View

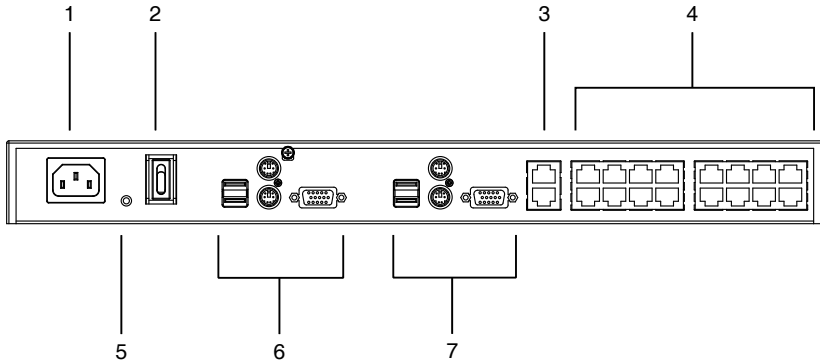

**Note:** The KH2516 is pictured above. The KH2508 rear panel is the same as that of the KH2516, except that it has 8 KVM ports instead of 16.

No.	Component	Description
1	Power Socket	The power cord to the AC source plugs in here.
2	Power Switch	This is a standard rocker switch that powers the KH2508 / KH2516 on and off.
3	Cascade Ports	When cascading units, the Cat 5e cables plug in here.
4	KVM Port Section	The Cat 5e cables that link the KVM adapter cables to the KH2508 / KH2516 plug in here.
5	Grounding Terminal	The grounding wire used to ground the unit attaches here.
6	Console 1 Port Section	See <i>Local Console Connection</i> , page 9 for details.
7	Console 2 Port Section	See <i>Local Console Connection</i> , page 9 for details.

## Local Console Connection

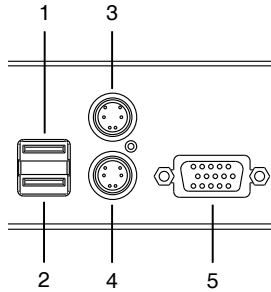

No.	Component	Description
1	USB Mouse Port	Use the USB mouse port to connect a USB mouse to the console.
2	USB Keyboard Port	Use the USB keyboard port to connect a USB keyboard to the console.
3	PS/2 Mouse Port	Use the PS/2 mouse port to connect a PS/2 mouse to the console.
4	PS/2 Keyboard Port	Use the PS/2 keyboard port to connect a PS/2 keyboard to the console.
5	HDB-15 Video Port	Use the HDB-15 video port to connect a monitor to the console.

This Page Intentionally Left Blank

# Chapter 2

## Hardware Setup

### Overview

---

For convenience and flexibility that allows mixing the PS/2, USB and serial interfaces, the KH2508 / KH2516's design utilizes KVM adapter cables that serve as intermediaries between the KVM switch and the connected devices:

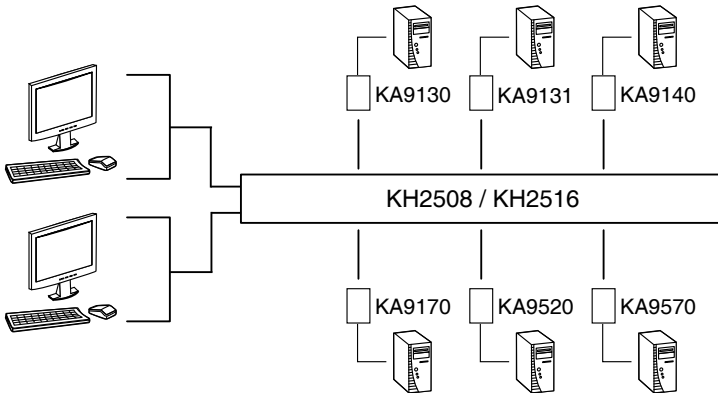

A separate KVM adapter cable is required for each computer or device connection. The KVM adapter cables are listed in the *KVM Adapter Cables* section on page 4. Consult your dealer to find out which KVM adapter cables best fit your needs.

### Before you Begin

---



1. Important safety information regarding the placement of this device is provided on page 69. Please review it before proceeding.
2. Make sure that the power to any device that you connect to the installation has been turned off. You must unplug the power cords of any computers that have the Keyboard Power On function.

## Stacking and Rack Mounting

---

The KH2508 / KH2516 can be stacked on a desktop or rack mounted in 1U of rack space. The procedures for each method are described in the following sections.

- 
- Note:** 1. Allow at least 5.1 cm on each side for adequate ventilation and 12.7 cm at the rear for power cord and cable clearance.
2. The standard rack mounting kit does not include screws or cage nuts. If you need additional screws or cage nuts, contact your rack dealer.
- 

### Stacking

The KH2508 / KH2516 can be placed on any level surface that can safely support its weight and the weight of the attached cables. Ensure that the surface is clean and free of materials that can block the exhaust vents or otherwise interfere with normal operation of the switch. A foot pad set is included with the unit. Peel the protective backing off of the foot pads, and then affix them to the bottom panel of the KH2508 / KH2516 near the corners, as shown in the diagram below.

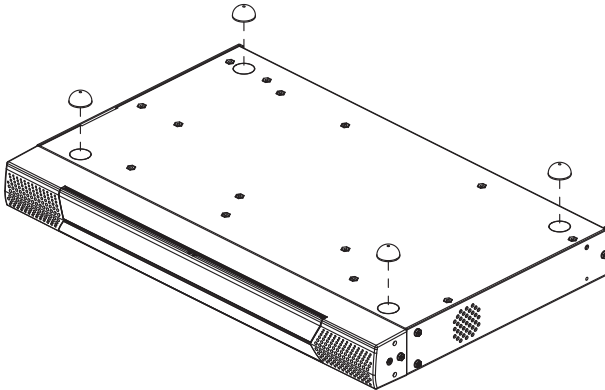

## **Rack Mounting – Front**

1. Remove 2 screws each from the left and right sides near the front of the switch (4 screws total).

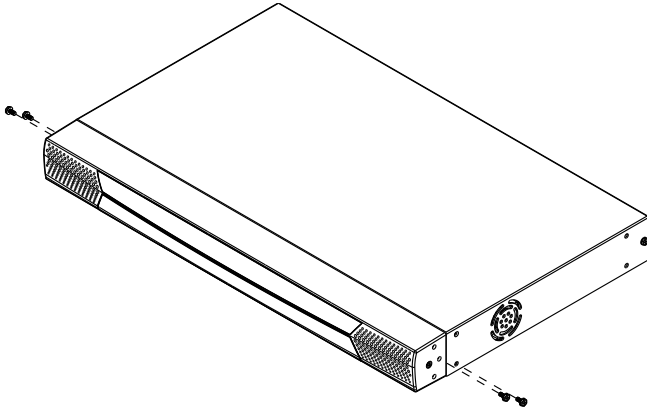

2. Use the M3 x 8 Phillips hex head screws supplied with the rack mounting kit to screw the rack mounting brackets into the sides at the front of the unit.

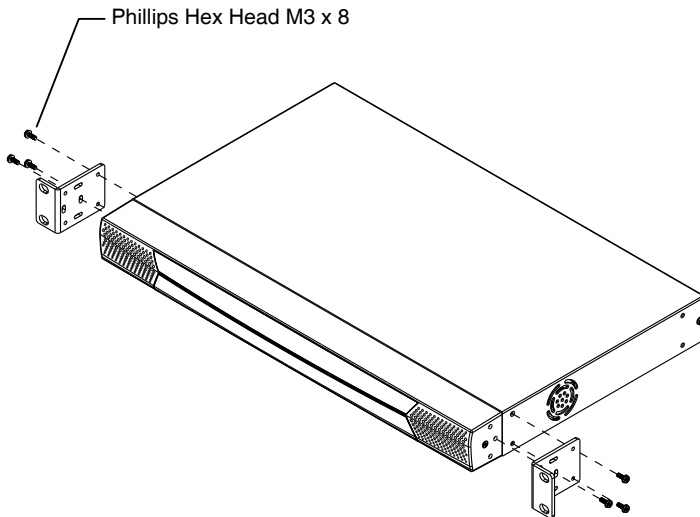

*(Continues on next page.)*

*(Continued from previous page.)*

3. Place the KVM switch in the rack. Position it so that the holes in the mounting brackets line up with those in the rack. Secure the mounting brackets to the front of the rack.

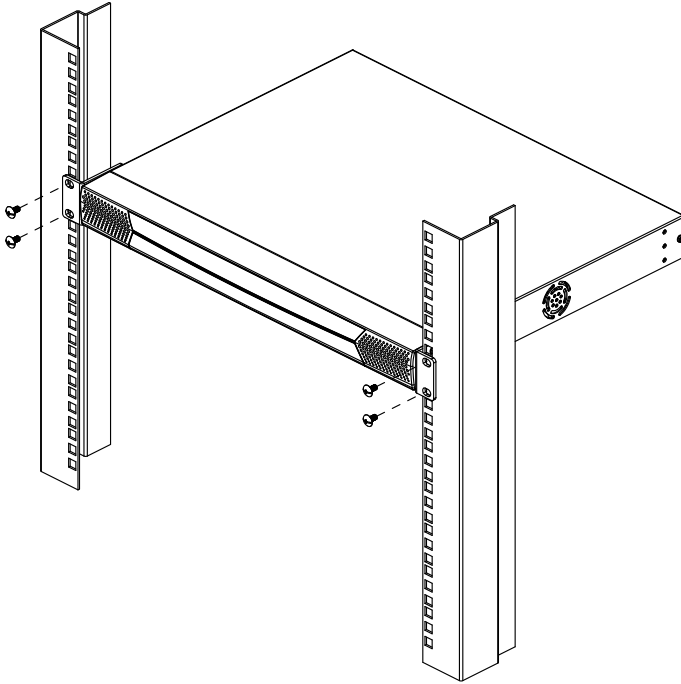



## **Rack Mounting – Rear**

1. Remove 1 screw each from the left and right sides near the rear of the switch (2 screws total).

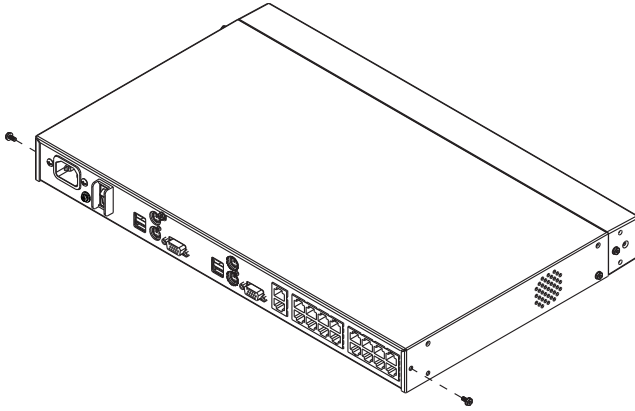

2. Use the M3 x 8 Phillips head hex screws supplied with the rack mounting kit to screw the rack mounting brackets into the sides at the rear of the unit.

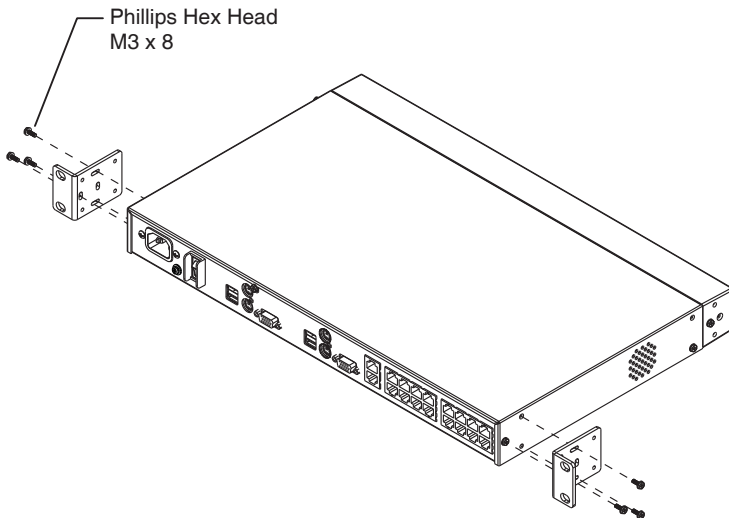

*(Continues on next page.)*

(Continued from previous page.)

3. Place the KVM switch in the rack. Position it so that the holes in the mounting brackets line up with those in the rack. Secure the mounting brackets to the rear of the rack.

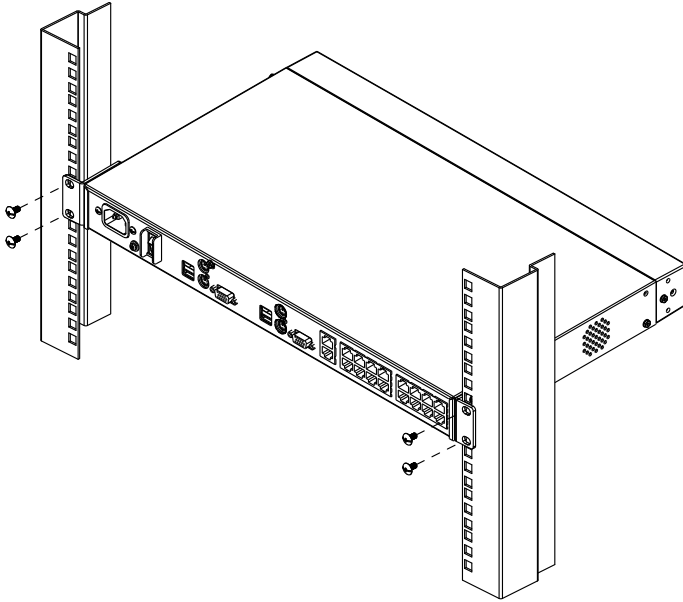

## Grounding

To prevent damage to your installation it is important that all devices are properly grounded.

Use a grounding wire to ground the KH2508 / KH2516 by connecting one end of the wire to the grounding terminal, and the other end of the wire to a suitably grounded object.

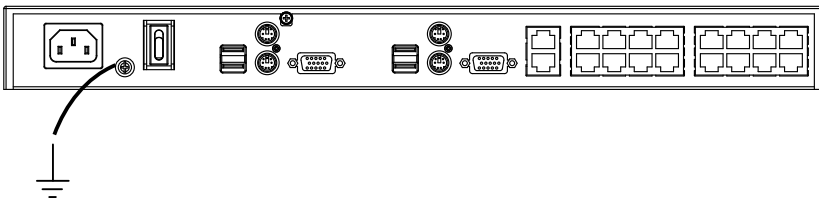

## Single Level Installation

---

In a single level installation, there are no additional KVM switches cascaded from the first-level KVM switch. To set up a single level installation, refer to the diagram on page 18 and do the following:

1. Plug a keyboard, monitor, and mouse into the KH2508 / KH2516's Console 1 ports. Each port is color coded and marked with an identifying icon. A second keyboard, monitor, and mouse can be connected to the KH2508 / KH2516's Console 2 ports.
2. Plug the KVM adapter cable connectors into the appropriate ports of the computer you are installing. (See *KVM Adapter Cable Installation Diagrams*, page 19 for connection examples.)
3. Use Cat 5e cable to connect a compatible KVM adapter cable to any available KVM port on the KH2508 / KH2516. (Repeat steps 2 and 3 for all computers that you wish to connect. Up to 8 or 16 computers may be connected in this fashion.)

---

**Note:** The distance between any KVM adapter cable and switch must not exceed 40 m (130 feet).

---

4. Plug the power cord into the KH2508 / KH2516's power socket first, then plug the power cord into an AC power source.
5. Turn on the power to the KH2508 / KH2516.

After the KH2508 / KH2516 is powered up, you can turn on the computers.

## Single Level Installation Diagram

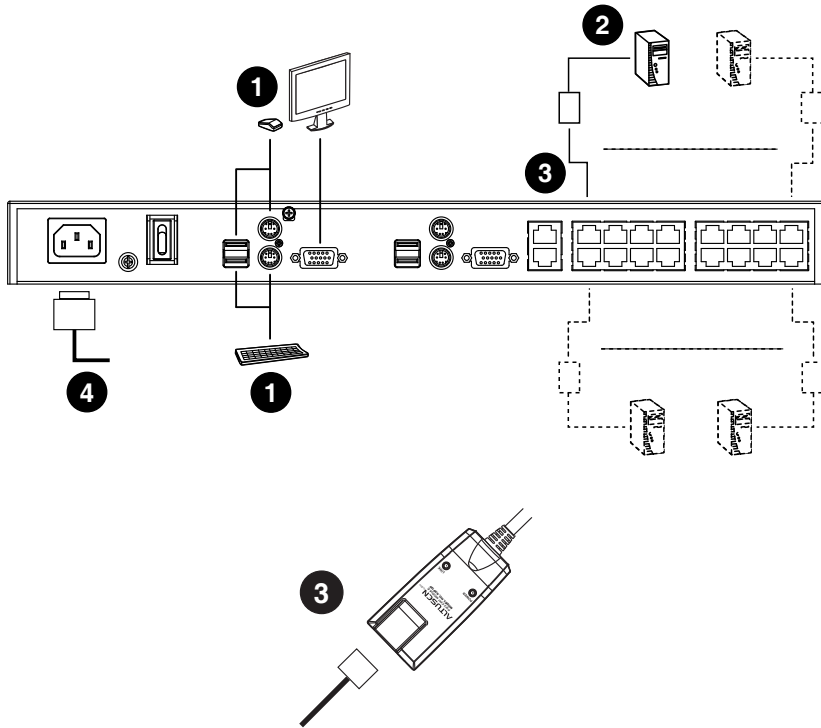

**Note:** 1. Although the KH2516 is pictured in the diagram, the installation process is the same for the KH2508.

2. The numbers in the diagrams correspond to the numbered steps of *Single Level Installation* on the previous page.

## KVM Adapter Cable Installation Diagrams

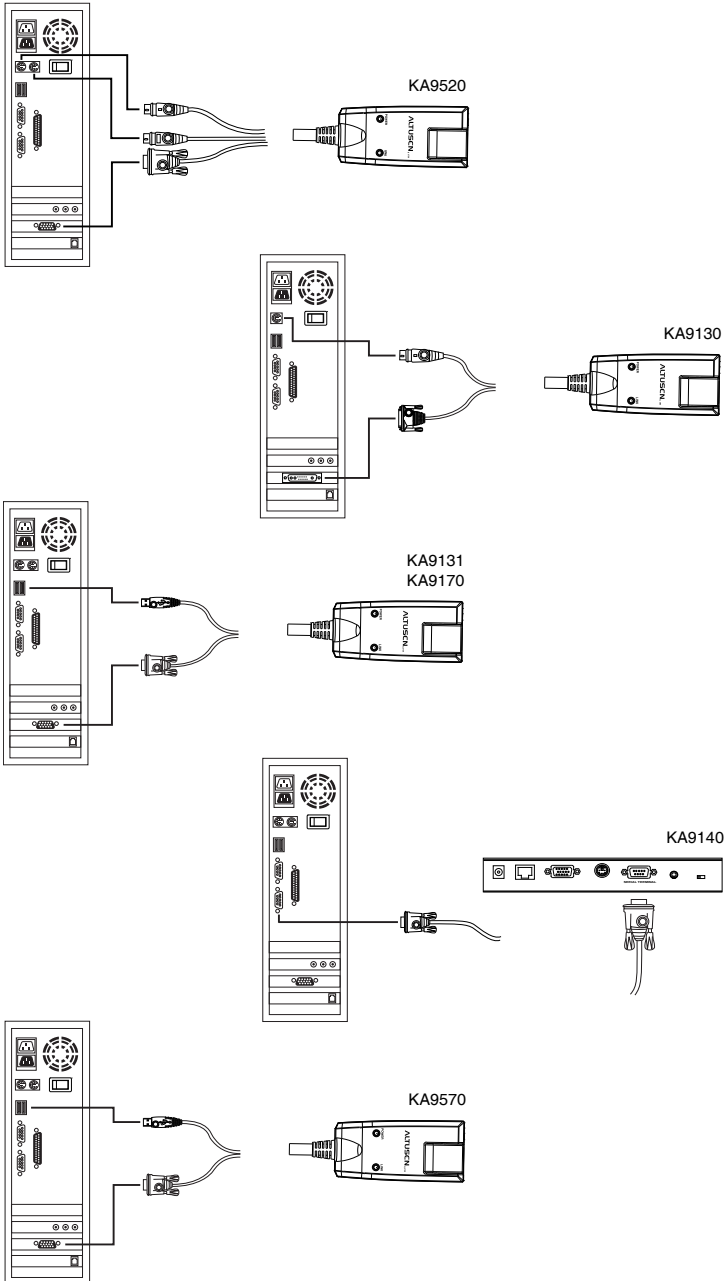

## Cascaded Installations

---

The number of computers that can be added to your installation can be greatly expanded by performing a cascaded installation. Cascading involves using the KVM ports of a *Parent* KVM switch (one that is above a switch linked down from it) to connect to a *Child* KVM switch. Cascading adds capacity to a KVM installation, but the parent loses at least one KVM port for each cascaded KVM switch.

The KH2508 / KH2516 supports cascading up to 3 levels of KH2508 / KH2516 switches. When the KVM consoles of the first-level KVM switch invoke the OSD, all computers on the cascaded KVM installation are listed in the port directory.

In cascaded installations, the number of bus connections between a parent and child KVM switch determines the number of users that can simultaneously access the KVM ports of a child switch. A bus connection is established by connecting a KVM port on the parent switch to a cascade port on the child switch. The KH2508 / KH2516 supports a maximum of two bus connections for each cascaded KH2508 / KH2516.

In order for both KVM consoles on the first-level KH2508 / KH2516 to be able to access the KVM ports of any cascaded KH2508 / KH2516 at the same time, you must create two bus connections between every parent switch and child switch in the installation. This is called a **non-blocked** cascade configuration (see *Non-blocked Cascade Configuration Installation Diagram*, page 22). In a non-blocked cascade configuration, the console connectors of the child switches are inoperable.

If only a single bus connection is created between a parent switch and a child switch, then only one of the consoles connected to the parent switch will have access to a child switch at any time. However, the second console can still control and access the ports of the parent switch. This is called a **blocked** cascade configuration (see *Blocked Cascade Configuration Installation Diagram*, page 23). In a blocked cascade configuration, only one console of each child switch is available to access the KVM ports on the same level or a lower level switch.

KVM consoles connected to cascaded switches cannot access the ports of a parent switch(es) and can perform only port switching and user profile changes; no other administrative functions can be executed.

## Cascading KH2508 / KH2516 Cat 5 KVM Switches

To cascade KH2508 / KH2516 Cat 5 KVM Switches, refer to the installation diagram on page 22 and do the following:

---

**Note:** Before cascading additional KH2508 / KH2516, ensure that the firmware version of the KH2508 / KH2516 to be installed matches that of the first-level KH2508 / KH2516. If necessary, perform a firmware upgrade on the cascaded switch first (see *The Firmware Upgrade Utility*, page 57).

---

1. Plug a keyboard, mouse, and monitor into the Console 1 ports on the first-level KH2508 / KH2516. Each port is marked with an identifying icon.  
(Repeat step 1 for a second KVM console that you wish to connect.)

---

**Note:** The total distance between any KVM switch and any KVM adapter cable in the installation (for example, between the first-level switch and a third-level KVM adapter cable) cannot exceed 40 m (130 feet).

---

2. Use Cat 5e cable to connect up to 8/16 KVM ports on the first-level switch to the cascade port(s) on the second-level switches in either a blocked or non-blocked configuration (see diagrams on the following pages).  
(Repeat step 2 for each third-level switch that you wish to cascade.)
3. Plug the connectors on the KVM adapter cables into the computers you wish to install and use Cat 5e cable to connect the KVM adapter cables to any available KVM port.
4. Plug the provided power cable into the power socket on the first-level KH2508 / KH2516; connect the power cable to an AC power source with appropriate voltage for the KH2508 / KH2516, then turn it on.
5. Wait one minute, then repeat step 4 for each second-level KH2508 / KH2516.
6. Wait one minute, then repeat step 4 for each third-level KH2508 / KH2516.
7. Turn on the power to all the computers.

## Non-blocked Cascade Configuration Installation Diagram

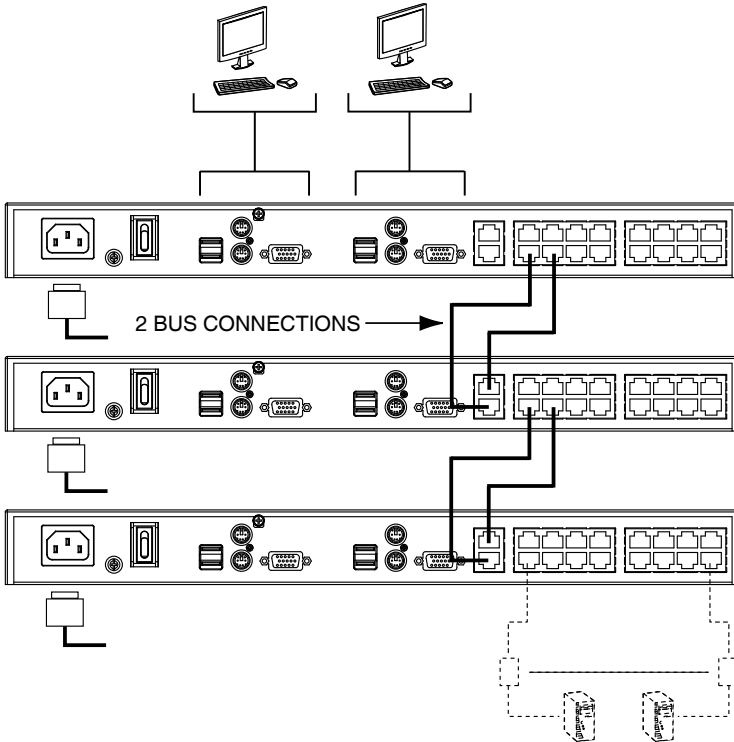

**Note:** Although the KH2516 is pictured in the diagram, the installation process is the same for the KH2508.



## Blocked Cascade Configuration Installation Diagram

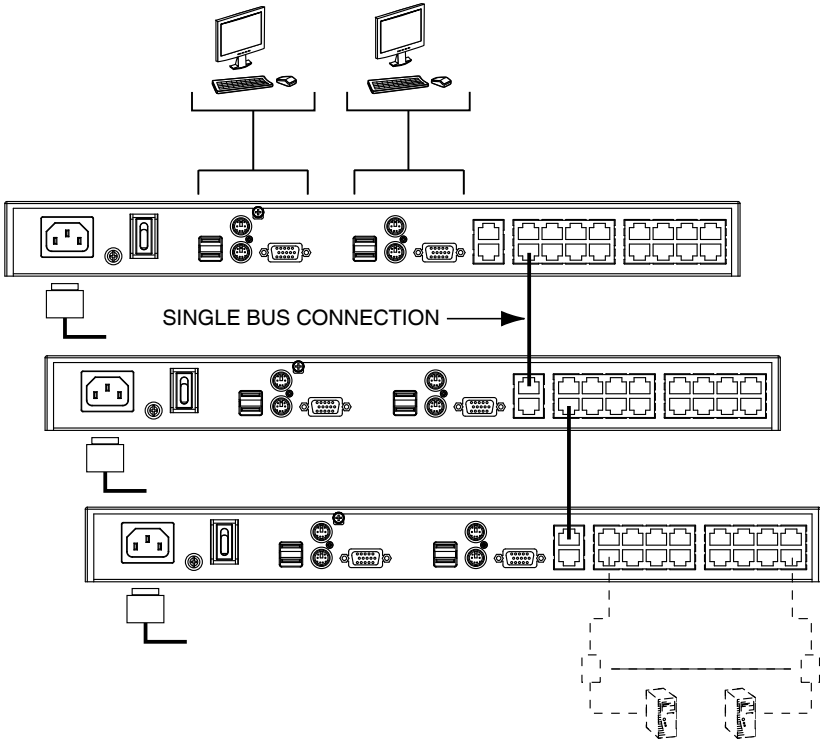

**Note:** Although the KH2516 is pictured in the diagram, the installation process is the same for the KH2508.

This Page Intentionally Left Blank

# Chapter 3

## Basic Operation

### Hot Plugging

---

The KH2508 / KH2516 supports *hot plugging* – components can be removed and added back into the installation by unplugging their cables from the ports without the need to shut down the switch. In order for hot plugging to work properly, the procedures described below must be followed:

### Changing Cascaded Switch Positions

You can change the position of a cascaded KH2508 / KH2516 by simply unplugging it from the old parent switch and plugging into a new one. The port names are automatically synchronized with the new position in the installation.

### Hot Plugging Console Ports

The keyboard, monitor, and mouse can be hot plugged. If you experience a problem after you plug in a new mouse, do a system reset by pressing the reset button on the KH2508 / KH2516's front panel (see page 6 for details). If this doesn't solve the problem, restart the computers that have the problem.

### Powering Off and Restarting

---

Powering off the KH2508 / KH2516 does not affect the computers attached to it. When you restart the KH2508 / KH2516, you regain control of the attached computers immediately. To replace a KH2508 / KH2516, simply power it down, unplug the cables, plug them into the new switch, and turn on the new switch.

---

**Note:** If any of the computers behave strangely after powering off and restarting, or changing a switch, simply restart the computer.

---

### Port Selection

---

Port selection is accomplished by means of the KH2508 / KH2516's OSD as detailed in Chapter 4.

This Page Intentionally Left Blank

# Chapter 4

## OSD Operation

### OSD Overview

---

The KH2508 / KH2516 OSD provides a graphical interface that offers quick and convenient computer access and control, as well as efficient system administration including user management (access rights, passwords, etc.).

Once the KH2508 / KH2516 has been cabled up, the next step that an Administrator needs to perform is setting the unit up for user operation. After a keyboard, monitor and mouse have been connected and the KH2508 / KH2516 turned on, a login prompt appears on the console monitor:

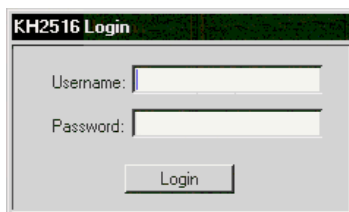



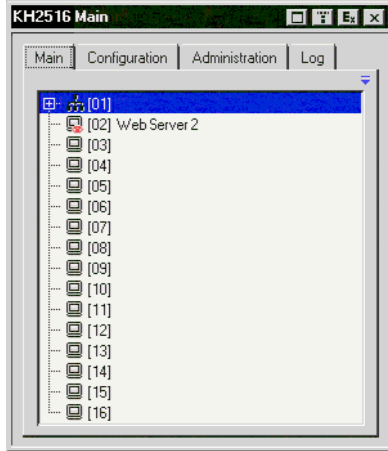

Since this is the first time you are logging in, use the default Username: *administrator*; and the default Password: *password*. For security purposes, we strongly recommend you use the *User Management* function (see page 43) to change the default Username and Password and give yourself a unique Username and Password with the appropriate permissions.

After successfully logging in, the OSD appears:



The OSD consists of four pages (Main, Configuration, Administration, and Log), each with a specific set of functions. Each page is discussed in the sections that follow.

The functions of the four buttons at the right of the title bar are described in the table below. Functions can be invoked by clicking the icon, or by pressing its associated function key.

Button	Key	Function
	F6	<b>Screen View:</b> Depending on the display resolution of the port you are viewing, the OSD it may appear smaller than normal. Use this function to return the OSD to its original size and blank the background. Click again to recover the background.
	F7	<b>Transparency:</b> Makes the OSD semi transparent, allowing the background to show through. Clicking again, returns the OSD to normal.  Note: 1. We recommend setting your monitor refresh rate to a value greater than 75Hz before using this feature. 2. If you switch to a null port when Transparency is enabled, the feature becomes disabled.
	F8	<b>Log Out:</b> Closes the OSD display and logs you out of the session.
	Esc	<b>Close:</b> Closes the OSD display but does not log you out of the session. You can bring the display back with the OSD hotkeys (see <i>OSD Hotkey</i> , page 41).

---

## The Main Page

---

The Main page lists the KH2508 / KH2516 ports and governs port access. Selecting a port and double clicking it switches you to the device on that port.

---

**Note:** Only those ports available to the currently logged in user are shown in the port list.

---

- ◆ A *switch icon*, in the shape of a small black box above and connected to 3 other black boxes, displays to the left of the port number of a cascaded switch.
- ◆ A *port icon* in the shape of a monitor displays to the left of the device port number. Ports that have powered devices connected to them have the icon lit green.

---

**Note:** The port icon lights green when the KVM adapter cable connected to the port is attached to, and receives power from, a computer. This does not mean that the attached computer is turned on. The port icon will light green even if the attached computer is turned off, so long as it supplies power to the KVM adapter cable.

---

- ◆ Ports that have been selected as Quick View ports (see page 30) have a red *eye* displayed with the port icon.

In addition to using this page to select ports to switch to, users can enable/disable their Quick View status for selected ports, while administrators can create, modify, or delete names for each of the ports.

- 
- Note:**
1. In cascaded installations, parent switches will also list the ports of child switches.
  2. Cascaded switches have their port lists collapsed by default. To expand a cascaded switch's port list, click the "+" symbol to the left of the switch icon. To collapse a cascaded switch's port list, click the "-" symbol.
-

## Quick View Ports

Selecting certain ports as Quick View ports is a way of limiting which ports are included when the KH2508 / KH2516 is in auto scan mode. If the KH2508 / KH2516 is configured to only auto scan ports that have Quick View status (see *Scan Target*, page 41), designating a port as a Quick View port in this dialog box means that it will be included when auto scanning is in effect.

The spacebar toggles a port's Quick View status. To select/deselect a port, highlight it and press the spacebar. When a port has been selected as a Quick View port, a red *eye* icon displays with the monitor icon in the port icon column. When a port isn't selected, there is no red eye icon in the column.

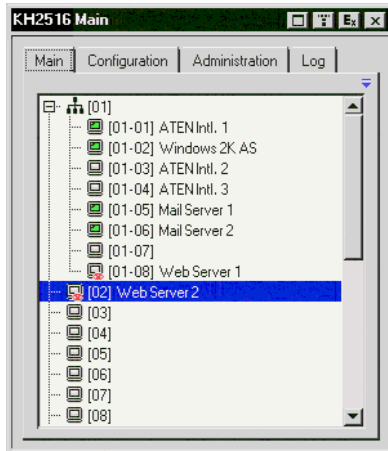



## The List Function

The List Function lets you broaden or narrow the scope of which ports the OSD displays in the Main Screen. To invoke the List Function, click the arrow at the upper right corner of the screen, or press **[F3]**.

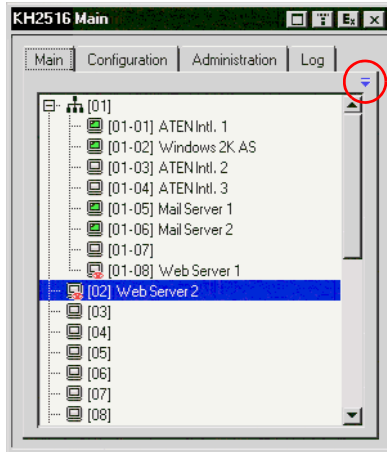

The screen changes to allow you to choose the ports that will be listed.

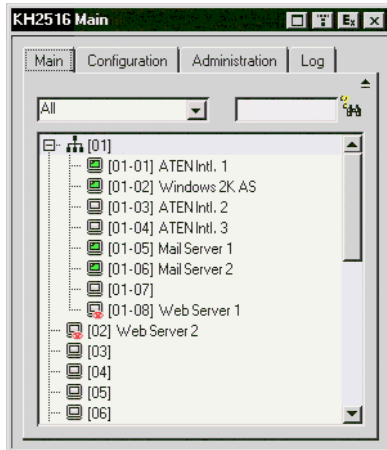

The drop down list on the left offers four fixed choices as shown in the table below.

Choice	Meaning
All	Lists all of the ports on the installation.
Powered On (PW)	Lists only the ports that have their attached devices powered on (see <i>port icon</i> note on page 29).
Quick View (QV)	Lists only the ports that have been selected as Quick View ports
Quick View + Powered On	Lists only the ports that have been selected as Quick View Ports (see page 30), and that have their attached devices Powered On (see <i>port icon</i> note on page 29).

The text input box on the right allows you to key in a port name so that only port names that match what you key in show up in the list. Wildcards are acceptable (? and \*), so that more than one port can show up in the list. Note also that the text input box is case sensitive, so that if you key in **Web\***, both Web Server 1 and Web Server 2 show up in the list, as shown below.

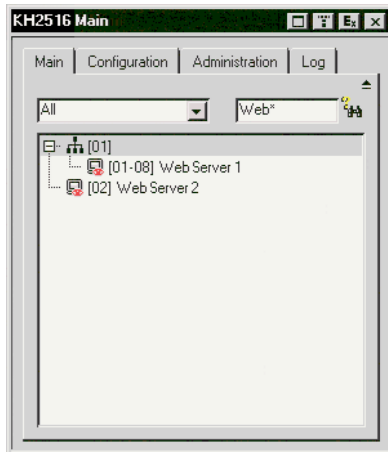

- ◆ After you key in your string, either click the binoculars to the right of the box, or press **[Enter]**.
- ◆ To go back to the default view, erase the string and either click the binoculars to the right of the box, or press **[Enter]**.
- ◆ To dismiss the List function, click the arrow or press **[F3]**.

## Port Names

To help remember which computer is attached to a particular port, every port can be given a name. This field allows administrators to create, modify, or delete port names.

To configure a port name:

1. Click once on the port you want to edit, then either press **[F2]**, or click again on the highlight bar.

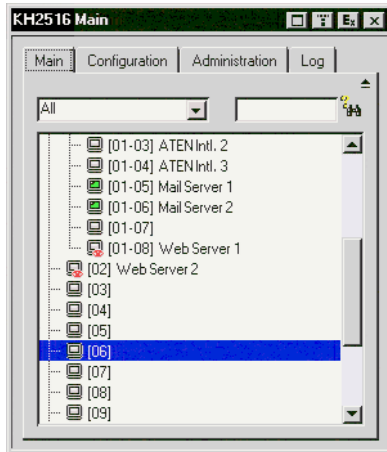

---

**Note:** This is not a double-click. It involves two separate clicks. A double-click will switch you to the device attached to the port.

---

*(Continues on next page.)*

(Continued from previous page.)

After a second, the bar changes to provide you with a text input box.

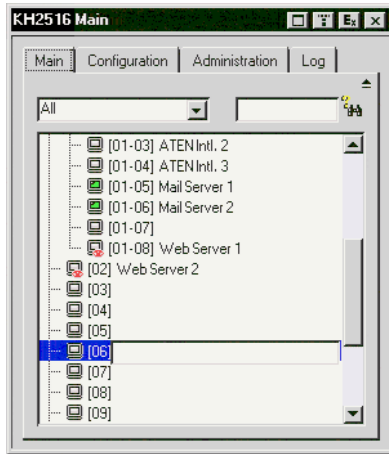

2. Key in the new port name, or modify/delete the old one. Port names are case sensitive.

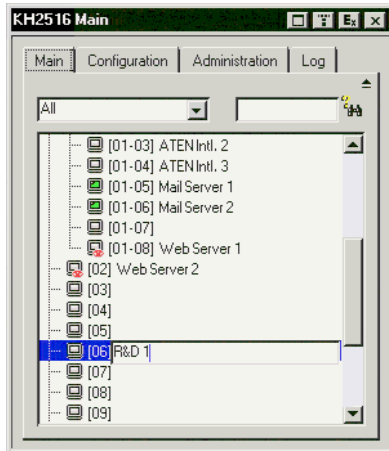

- When you have finished editing the port name, click anywhere outside of the input box to complete the operation.

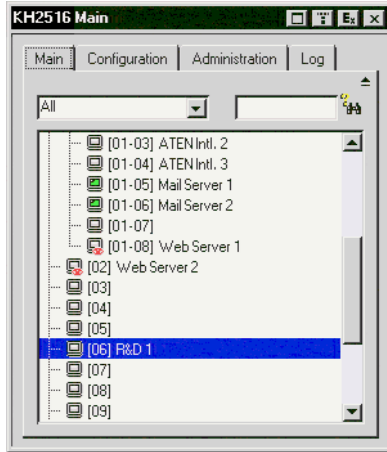

**Note:** Port names are stored in the KVM adapter cables. When a cable is disconnected from one port and reconnected to another port, the port name will show in both the old port and the new port in the port list until another KVM adapter cable is connected to the old port, or the port name is changed manually.

## Port Operation

---

Select a port on the OSD Main screen either by moving the highlight bar to it with the up and down arrow keys and pressing **[Enter]**, or by double-clicking it. Once you select a port, its screen displays on your monitor, and your keyboard and mouse input affects the remote system.

- 
- Note:** 1. If you invoke the OSD while accessing a target device from the local console, press **[F6]** to hide the background and enlarge the OSD. Press **[F6]** again to show the background.
2. An administrator selects which ports are accessible to each user (see *User Management*, page 43 for details).
- 

### The OSD Toolbar

The OSD provides a toolbar to help you control the KH2508 / KH2516 from within the selected port. To bring up the toolbar, tap the OSD Hotkey (Scroll Lock or Ctrl) twice. The toolbar appears at the upper left corner of the screen:













Depending on the settings that were selected for ID Display (see page 41), the port number and/or the port name display at the right of the toolbar. The toolbar icons are described on page 37.

- 
- Note:** When the toolbar displays, mouse input is confined to the toolbar area and keyboard input has no effect. To carry out operations on the computer connected to the port, you must exit the toolbar by either clicking the icon that closes the toolbar (see *The Toolbar Icons*, page 37), or by pressing **[Esc]** once.
-

## The Toolbar Icons

The toolbar icons are described in the table below.

Icon	Purpose
	Drag this icon to move the toolbar to a different location.
	Click to skip to the first accessible port on the entire installation without having to invoke the OSD.
	Click to skip to the first accessible port previous to the current one without having to invoke the OSD.
	Click to begin Auto Scan mode. The KH2508 / KH2516 automatically switches among the ports that were selected for Auto Scanning under the Scan Target function (see page 41). This allows you to monitor their activity without having to switch among them manually.
	Click to skip from the current port to the next accessible one without having to invoke the OSD.
	Click to skip from the current port to the last accessible port on the entire installation without having to invoke the OSD.
	Click to display the OSD.
	Click this button to make the OSD display semitransparent, allowing whatever the OSD screen is covering to show through. Clicking the button again, returns the OSD screen to normal opacity. <b>Note:</b> <ul style="list-style-type: none"> <li>◆ We recommend setting your monitor refresh rate to a value greater than 75Hz before using this feature.</li> <li>◆ If you switch to a null port when transparency is enabled, the feature becomes disabled.</li> </ul>
	Click to close the toolbar.
	Click to logout and exit the application.
	Clicking this button cycles you through the KVM adapter cable's compensation mode choices depending on the length of cable used to connect a device to the KH2508 / KH2516. The choices are, <i>Short</i> : less than 10 m, <i>Medium</i> : 10–25 m, and <i>Long</i> : 25–40 m. The length of the line in the icon changes to indicate which choice is selected.

## **Recalling the OSD**

To dismiss the toolbar and bring back the OSD display, do one of the following:

- ◆ Tap the OSD Hotkey once.
- ◆ From the toolbar, click the icon that opens the OSD (see page 37).

The OSD toolbar closes, and the main OSD display reappears.

## **OSD Hotkey Summary Table**

The following table presents a summary of the OSD Hotkey actions. See page 41 to set the OSD Hotkey.

<b>To...</b>	<b>When...</b>	<b>Do This...</b>
Open the OSD Toolbar.	The OSD Toolbar is not open.	Press the OSD Hotkey twice.
Open the OSD.	The OSD Toolbar is open.	Press the OSD Hotkey once.
Open the OSD.	The OSD Toolbar is not open.	Press the OSD Hotkey three times.

## **Port Operation Hotkey Overview**

Port operation hotkeys allow you to provide KVM focus to a port directly from the keyboard. The KH2508 / KH2516 provides the following port operation hotkey features:

- ◆ Auto Scanning
- ◆ Skip Mode Switching

---

**Note:** 1. The hotkeys are: **A** and **P** for Auto Scanning; and the **Arrow Keys** for Skip Mode switching.

2. In order for hotkey operations to take place, the OSD toolbar must be visible (see *Port Operation*, page 36).

3. When the OSD toolbar is visible, hotkeys cannot be used for normal purposes. To use hotkeys for normal purposes, you must close the OSD toolbar.

---



## **Auto Scanning**

The Auto Scan function automatically switches among all the ports that are accessible to the currently logged on user at regular intervals, so that he can monitor their activity automatically. (See *Scan Target*, page 41, for information regarding accessible ports).

### **Setting the Scan Interval**

The Scan Interval (the amount of time Auto Scan dwells on each port) is set with the Scan Duration setting (see *Scan Target*, page 41).

### **Invoking Auto Scan**

To start Auto Scanning, with the OSD toolbar showing, tap the [A] key. The Auto Scan function cycles through the ports in order - starting from the first port on the installation. An **S** appears in front of the Port ID Display to indicate that the port is being accessed under Auto Scan Mode.

### **Pausing Auto Scan**

While you are in Auto Scan Mode, you can pause the scanning in order to keep the focus on a particular computer by pressing **P**. During the time that Auto Scanning is paused, the **S** in front of the Port ID blinks On and Off.

*Pausing* when you want to keep the focus on a particular computer can be more convenient than exiting Auto Scan Mode because when you *Resume* scanning, you start from where you left off. If, on the other hand, you were to exit and then restart Auto Scan Mode, the scanning would start over from the very first computer on the installation.

To *Resume* Auto Scanning after a pause, press any key except [Esc] or the [Spacebar]. Scanning continues from where it left off.

### **Exiting Auto Scan Mode**

While Auto Scan Mode is in effect, ordinary keyboard functions are suspended. You must exit Auto Scan Mode in order to regain normal control of the keyboard. To exit Auto Scan Mode press [Esc] or the [Spacebar]. Auto Scanning stops when you exit Auto Scan Mode.

## Skip Mode

Skip Mode allows you to switch ports in order to monitor the computers manually. You can dwell on a particular port for as long or as little as you like – as opposed to Auto Scanning, which automatically switches after a fixed interval. The Skip Mode hotkeys are the four arrow keys. Their operation is explained in the table below.

Arrow	Action
←	Skips from the current port to the first accessible port previous to it. (See <i>Scan Target</i> , page 41, for information regarding accessible ports.)
→	Skips from the current port to the first accessible port that comes after it.
↑	Skips from the current port to the very first accessible port on the installation.
↓	Skips from the current port to the very last accessible port on the installation.

## The Configuration Page

The Configuration page allows users to set up their own, individual, working environments. The KH2508 / KH2516 stores a separate configuration record for each user profile, and sets up the working configuration according to the username that was keyed into the login dialog box.

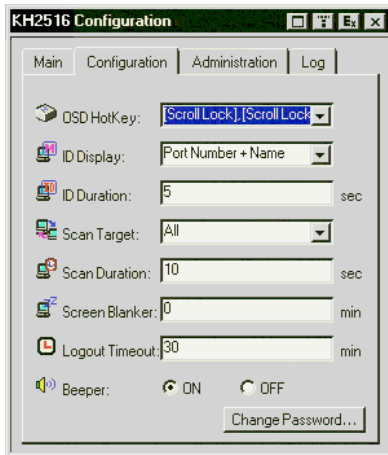

The configuration page settings are explained in the following table:

Setting	Function
OSD Hotkey	Selects which Hotkey controls the OSD function: <b>[Scroll Lock]</b> , <b>[Scroll Lock]</b> , or <b>[Ctrl] [Ctrl]</b> . Since the Ctrl key combination may conflict with programs running on the computers, the default is the Scroll Lock combination.
ID Display	Selects how the Port ID is displayed: the Port Number alone ( <b>PORT NUMBER</b> ); the Port Name alone ( <b>PORT NAME</b> ); or the Port Number plus the Port Name ( <b>PORT NUMBER + PORT NAME</b> ). The default is PORT NUMBER + PORT NAME.
ID Duration	Determines how long a Port ID displays on the monitor after a port change has taken place. You can choose an amount from 0–255 seconds; a setting of 0 constantly displays the port ID. The default is 5 seconds.
Scan Target	Selects which computers will be accessed under Auto Scan Mode (see <i>Auto Scanning</i> , page 39). Choices are: <b>ALL</b> - All the Ports which have been set Accessible (see <i>Port Access</i> , page 45); <b>POWERED ON</b> - Only those Ports which have been set Accessible and are Powered On; <b>QUICK VIEW</b> - Only those Ports which have been set Accessible and have been selected as Quick View Ports (see <i>Quick View Ports</i> , page 30); <b>QUICK VIEW + POWERED ON</b> - Only those Ports which have been set Accessible and have been selected as Quick View Ports and are Powered On. The default is ALL.
Scan Duration	Determines how long the focus dwells on each port as it cycles through the selected ports in Auto Scan Mode (see <i>Auto Scanning</i> , page 39). Key in a value from 1–255 seconds. The default is 10 seconds; a setting of 0 disables the Scan function.
Screen Blanker	If there is no input from the console for the amount of time set with this function, the screen is blanked. Key in a value from 1–30 minutes. The default setting of 0 disables this function.
Logout Timeout	If there is no user input for the amount of time set with this function, the user is automatically logged out. A login is necessary before the KH2508 / KH2516 can be accessed again. Enter a value from 0–180 minutes. The default is 30 minutes. 0 disables the function.
Beeper	When set to <b>ON</b> , the beeper sounds whenever a port is changed, when activating the Auto Scan function (see <i>Auto Scanning</i> , page 39), or an invalid entry is made in an OSD menu. The default is ON.
Change Password	Allows the current user to change his own account password. After clicking the <i>Change Password</i> button, a dialog box appears. Enter the old password. Then, enter a new password and confirm it by entering it again. Press <b>OK</b> to save changes, or press <b>Cancel</b> to discard changes.

## The Administration Page

Each of the administrative functions is represented by an icon at the left of the page. Clicking the icon brings up its associated dialog box. When the Administration page first displays, the General page appears:



### General

The General page presents two items of information as described in the following table.

Item	Meaning
Device Name	This field lets you give the switch a unique name. This can be convenient when you need to differentiate among several devices in multistation installations.
F/W Version	This item displays the current firmware version number. You can reference it to see if there are newer versions available on the Aten website ( <a href="http://www.aten.com">www.aten.com</a> ).

## User Management

The User Management dialogs are used to create and manage user profiles. Up to 96 user profiles can be configured.

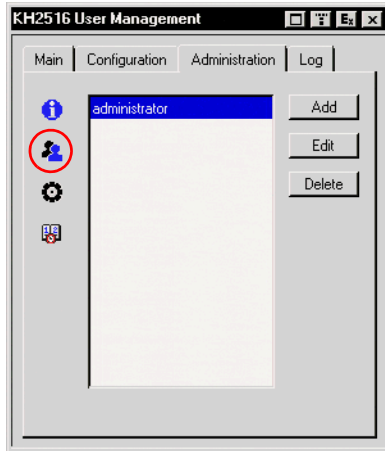

- ◆ To delete a user profile, select it in the list box, and click **Delete**.
- ◆ To modify a user profile, select it and click **Edit**.
- ◆ To add a user, click **Add**.

If you choose *Edit* or *Add*, a dialog box similar to the one below appears:

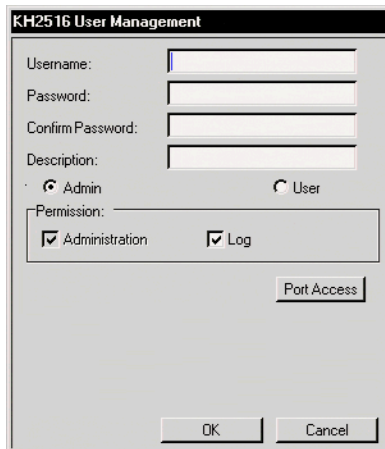

Fill in the required information for a new user profile, or modify the information to edit an existing profile. A description of the field headings is given in the table below.

Heading	Description
Username	A minimum of 6 and a maximum of 15 characters is allowed.
Password	A minimum of 8 and a maximum of 15 characters is allowed.
Confirm Password	To be sure there is no mistake in the password, you are asked to enter it again. The two entries must match.
Description	Additional information about the user that you may wish to include.
Admin	Select this to give the user Administrator level access to the KH2508 / KH2516. Administrators can set up and modify the KH2508 / KH2516 Administration page settings.
User	Select this to give the user user-level access to the KH2508 / KH2516. Users cannot access the Administration page.
Log	Checking <i>Log</i> allows an administrator or user to view the log file.
Port Access	See <i>Port Access</i> , page 45

## Port Access

Clicking *Port Access* in the *User Management* dialog brings up a screen similar to the one below. All ports on the installation, including those of cascaded switches, are shown in the dialog box. (If necessary, collapsed switch icons can be expanded to view their ports.)

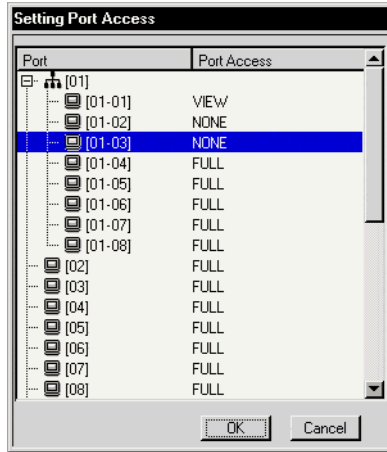

The port access function allows an administrator to define the selected user's access to the computers on a port-by-port basis.

For each user account, select a port and double-click on its port access type to cycle through the choices:

- ♦ **Full:** The user can view the remote screen and can perform operations on the remote system from his keyboard and monitor.
- ♦ **View:** The user can only view the remote screen, but cannot perform any operations on it.
- ♦ **None:** No access rights. The port will not show up on the user's list on the Main Screen.

Repeat until access rights have been set for all the ports. The default is *Full* for all users on all ports.

# System

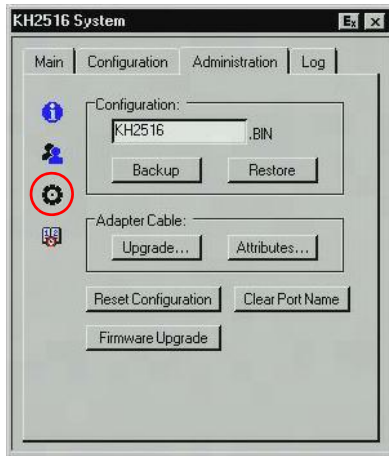

The System dialog box has several configurable options, as described below:

## **Configuration**

Saving a configuration file is a convenient way of backing up changes made to the Administration dialog boxes, including user profiles, etc.

**Note:** The configuration file is saved on the root of a USB flash drive connected to the Console's front panel USB port. (If you are accessing the OSD from Console 1, be sure to use a Console 1 USB port.)

- ◆ Enter a name for the configuration file (8 characters maximum).
- ◆ **Backup:** writes the configuration file to the Console's USB port.
- ◆ **Restore:** restores a configuration file from the Console's USB port.



## Adapter Cable

### Upgrade

Every adapter cable on the installation, including those of cascaded switches, are upgraded automatically when the first-level KH2508 / KH2516 firmware is upgraded. However, there may be times when individual or groups of adapter cables need to be upgraded separately, for example, when recovering from a failed adapter cable upgrade.

**Note:** This method of upgrading adapter cable firmware applies only to those adapter cables directly connected to the first-level KH2508 / KH2516. Adapter cables on cascaded switches cannot have their firmware upgraded using this method. For firmware upgrades to adapter cables on cascaded KH2508 / KH2516, see *Upgrading Adapter Cables*, page 64.

Upgrade allows you to upgrade the adapter cable firmware of selected ports. When you click **Upgrade...**, a dialog box similar to the one below appears.

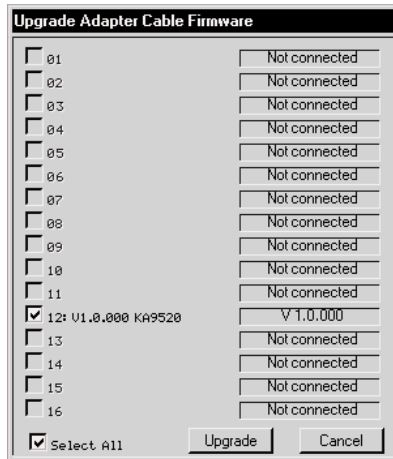

All ports with adapter cables attached are selected by default and can be upgraded by clicking **Upgrade**. Ports listed as *Not connected* will not be upgraded.

1. To make selecting individual ports easier, first deselect all the ports by clicking the checkbox next to **Select All**. (The *Select All* checkbox can toggle the selection of all the ports by alternately selecting, or deselecting all ports.)

---

**Note:** The adapter cable's firmware version is displayed next to its model number; the firmware version for the adapter cable stored in the KH2508 / KH2516 is displayed in the port information field on the right. If an adapter cable's firmware is higher than the one stored in the KH2508 / KH2516 firmware, download an updated version of the KH2508 / KH2516 firmware and perform a firmware upgrade on the installation (see *The Firmware Upgrade Utility*, page 57).

To leave the dialog box without performing an upgrade, click **Cancel**.

---

2. Next, individually select the ports you want to upgrade by clicking the checkboxes next to the port number.

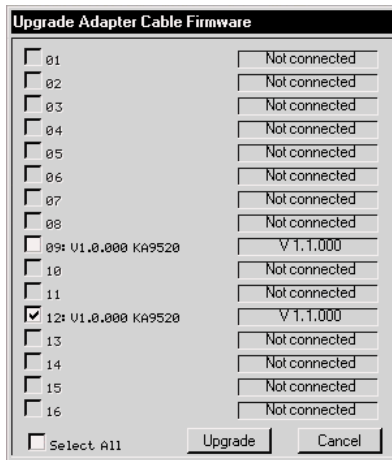

- To perform the firmware upgrade on the selected ports, click **Upgrade**.  
The status of the upgrade on a port displays in the port information field.

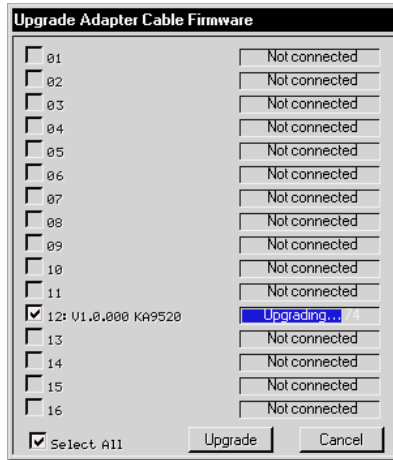

**Note:** Once an adapter cable upgrade is started, it cannot be cancelled and will not stop until an upgrade has been attempted on all selected ports.

- After the adapter cable has been upgraded, the upgrade status is indicated in the port information field for approximately 3 seconds.

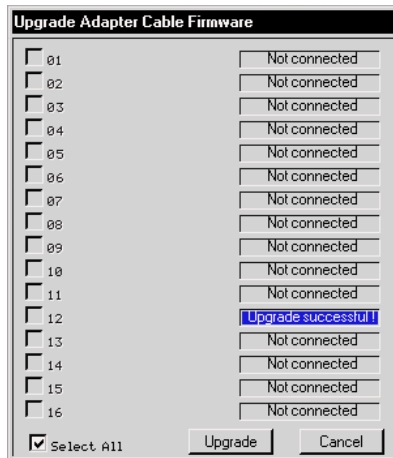

(Continues on next page.)

(Continued from previous page.)

- The port information field then displays the upgraded firmware version of the adapter cable:

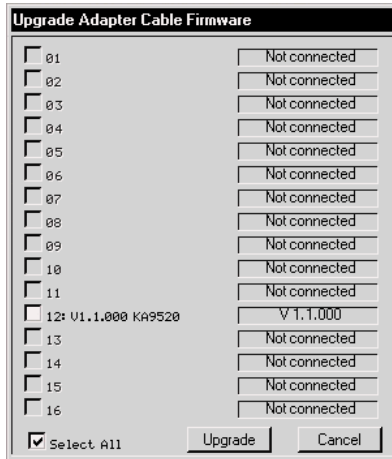

- Click **Cancel** to exit the *Upgrade Adapter Cable Firmware* dialog box and return to the *System* dialog box.

## Upgrade Failed

If a firmware upgrade to an adapter cable fails, the port information field displays an **Upgrade failed!** message.

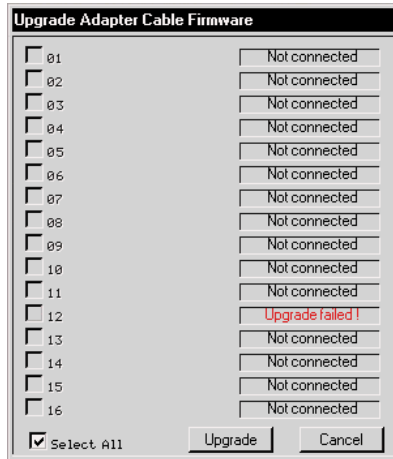

To recover from a failed adapter cable firmware upgrade:

1. Disconnect the adapter cable from its computer.
2. Move the *F/W UPGRADE* switch on the adapter cable to the **Recover** position.
3. Reconnect the adapter cable to the computer.
4. Perform an adapter cable firmware upgrade on the port.
5. After the adapter cable firmware has successfully upgraded, move the *F/W UPGRADE* switch on the adapter cable back to the **Normal** position.
6. Disconnect and reconnect the adapter cable from its computer, again.
7. Click **Cancel** to exit the *Upgrade Adapter Cable Firmware* dialog box and return to the *System* dialog box.

## Attributes

Attributes allow you to set the adapter cable attribute parameters for each port. When you click *Attributes...*, a dialog box similar to the one below appears:

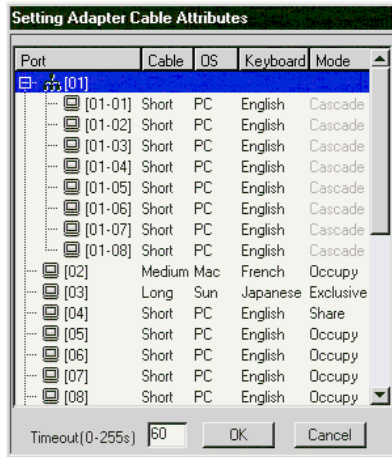

- ◆ The port numbers for all ports on the installation, including those from cascaded switches, are listed in the column on the left. A port's attributes are shown on the right. The purpose of each attribute is described in the table below:

Attribute	Purpose
Cable	Specifies the Cat 5e cable length that is used to connect the computer to the port. Choices are Short (less than 10 m), Medium (10–25 m), and Long (25–40 m). The default is Short.
OS	Specifies the operating system that the computer on the connected port is using. Choices are PC (for Windows, and serial devices), Mac (for MacOS), and Sun (for Sun Solaris). The default is PC.
Keyboard	Selects the keyboard layout that the computer on the connected port is using. Choices are English (American), French, German, Japanese, Traditional Chinese and UK English. The default is English.
Mode	Selects the Operation Mode for the port. Choices are Exclusive, Occupy, and Share (see <i>Operation Mode Attributes</i> , page 54). <b>Note:</b> The Operation Mode function applies to ports on the first level switch only and is disabled for all ports of cascaded switches. Instead, <i>Cascade</i> is displayed to indicate the port's Operation Mode cannot be changed.

- ♦ The *Timeout* field sets a time threshold for users on ports whose Operation Mode has been set to *Occupy* (see *Occupy*, page 54). If there is no activity from the user occupying the port for the amount of time set here, the user is timed out and keyboard and mouse control on the port is released, after which the first user to send keyboard or mouse input will occupy the port. However, the user originally connected to the port will still see the port's video output.

Input a value from 0 to 255 seconds. The default is 60 seconds. A setting of 0 causes the port to be released the instant there is no input.

## Changing Attributes

To change port attributes:

1. Double-click an attribute on a port to change it.

---

**Note:** The *Operation Mode* attribute is disabled for all ports on cascaded switches.

---

Double-clicking an attribute will cycle through its available options. For example, for the *Cable* attribute, double-clicking on the word *Short* will change it to *Medium*; Double-clicking on the word *Medium* will change it to *Long*; Double-clicking on the word *Long* will change it back to *Short*.

---

**Note:** All attributes support double-clicking to cycle through available options.

---

2. Click **OK** to keep your changes, or click **Cancel** to exit without saving your changes.

## Operation Mode Attributes

The Setting Adapter Cable Attributes dialog box has the following options for setting a port's operation mode:

Attribute	Action
Occupy	The first user to occupy the port has control over it. A second user can view its video output, however. The <i>Timeout</i> function, discussed above, applies to ports that have this setting.
Exclusive	The first user to occupy the port has exclusive control over it. No other user can view or access it.
Share	Allows 2 users connected to the first-level switch's consoles to simultaneously share keyboard and mouse control over a first-level port. User input is placed in a queue and executed sequentially. This is the default operation mode for all first-level ports. <b>Note:</b> KVM ports on cascaded switches cannot be shared.
Cascade	The first user to occupy the port has control over it and a second user can view its video output. When the first user disconnects from the port, the second user gains control of it. The <i>Timeout</i> function does not apply to users connected to cascaded ports. <b>Note:</b> This operation mode is assigned to all ports on cascaded switches and cannot be changed.

## Miscellaneous

The functions performed by the remaining elements at the bottom of the screen are described in the table, below:

Parameter	Explanation
Reset Configuration	Clicking this button undoes all changes that have been made to the Configuration and Administration pages (except for the Port Names – see <i>Port Names</i> , page 33, and user profiles – see <i>User Management</i> , page 43) and returns the parameters to the original factory default settings (see <i>Restoring Original Factory Default Settings</i> , page 78).
Clear Port Name	This function clears the Port Name settings.
Firmware Upgrade	Use the <i>Firmware Upgrade</i> button when performing a firmware upgrade to the KH2508 / KH2516, KVM adapter cables and cascaded switches in a multilevel installation. For information on performing a firmware upgrade, see <i>The Firmware Upgrade Utility</i> , page 57.



## Date/Time

The Date/Time dialog box lets the Administrator set up the KH2508 / KH2516's time parameters:

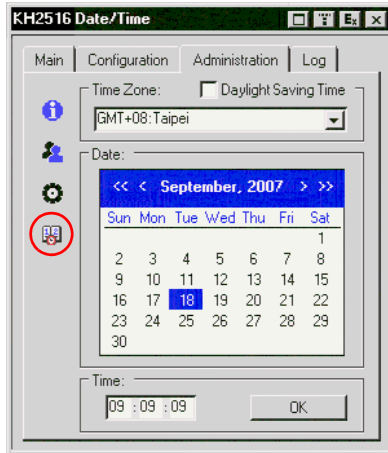

- ◆ If your country or region uses Daylight Saving Time (Summer Time), check the corresponding box.
- ◆ To establish the time zone that the KH2508 / KH2516 is located in, drop down the *Time Zone* list and choose the city that most closely corresponds to where it is.
- ◆ To set the year and day, use the Calendar graphic.
  - ◆ Clicking << or >> moves you backward or forward by one year increments.
  - ◆ Clicking < or > moves you backward or forward by one month increments.
  - ◆ In the calendar, click on the day.
- ◆ To set the time, use the 24 hour HH:MM:SS format.
- ◆ Click **OK** to save your changes.

## The Log Page

---

Clicking the Log tab brings up the contents of the log file. A screen similar to the one below appears:

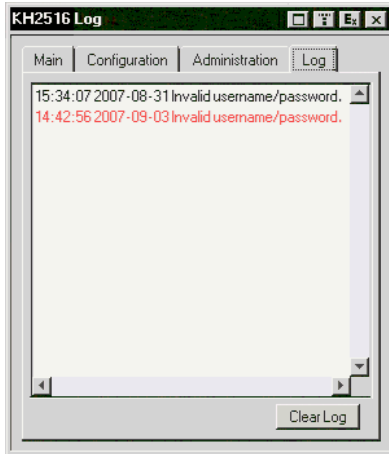

- ◆ The log file tracks a maximum of 512 events. When the limit is reached, the oldest events get discarded as new events come in.
- ◆ To clear the log file, click the **Clear Log** button.

# Chapter 5

## The Firmware Upgrade Utility

### Introduction

---

The purpose of the Windows-based Firmware Upgrade Utility is to provide an automated process for upgrading the KH2508 / KH2516 and compatible adapter cable firmware. The program comes as part of a Firmware Upgrade Package that is specific for each device.

As new firmware versions become available, new firmware upgrade packages are posted on our Website. Check the Website regularly to find the latest information and packages.

### Downloading the Firmware Upgrade Package

To download the firmware upgrade package:

1. From a computer that is not part of your KVM installation go to our Website and choose the model name that relates to your device. A list of available firmware upgrade packages appears.
2. Choose the firmware upgrade package that you wish to install (usually the most recent) and download it to your computer.

## **Preparing to Upgrade the Firmware**

To prepare to upgrade the firmware:

1. Notify all users to logout of the OSD on all switches in the installation.
2. Ensure that all computers are powered on; otherwise, some KVM adapter cables may not be upgraded.
3. Use the *Firmware Upgrade Cable* (provided with this unit), to connect a COM port on your computer (that was used to download the firmware upgrade package) to the *Firmware Upgrade Port* of your KH2508 / KH2516.

---

**Note:** 1. On a cascaded installation, connect the cable to the first level KH2508 / KH2516.

2. Make sure that the *Firmware Upgrade Switch*, located on the front panel, is switched to the **Normal** position (see page 6).
- 

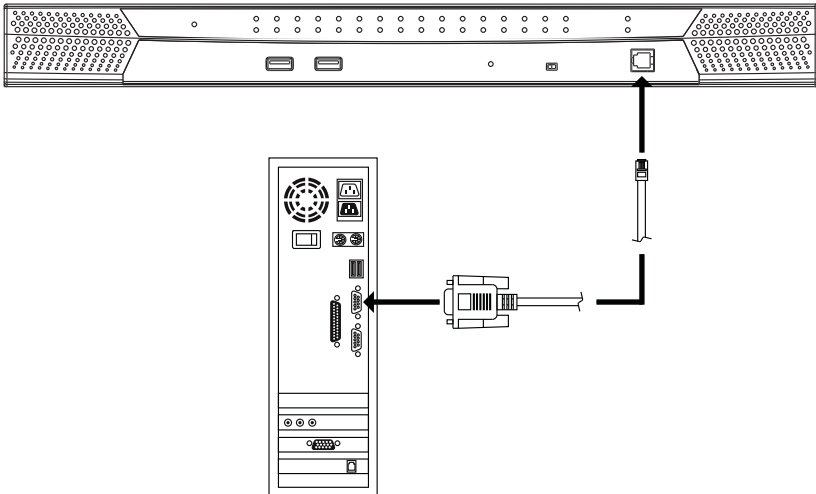

## Performing the Upgrade

Follow the instructions below to upgrade the firmware for all possible devices, including switches and adapter cables, in the KVM installation.

1. Log in to the OSD (see page 27) from a console connected to the first level KH2508 / KH2516.
2. Go to the *Administration Page* and click the icon to bring up the *System* dialog (see page 46).
3. Click **Firmware Upgrade**. The following dialog box appears:

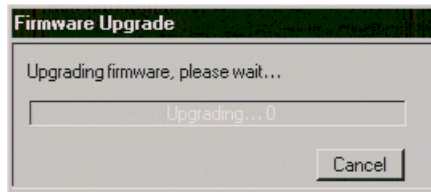

4. From the computer that was used to download the firmware upgrade package, run the downloaded Firmware Upgrade Package file – either by double clicking the file icon, or by opening a command line and keying in the full path to it.

The Firmware Upgrade Utility *Welcome* screen appears:

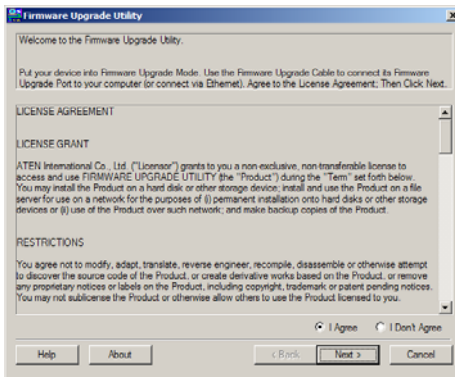

5. Read and *Agree* to the License Agreement (enable the I Agree radio button).
6. Click **Next** to continue. The Firmware Upgrade Utility main screen appears and the utility searches for devices.

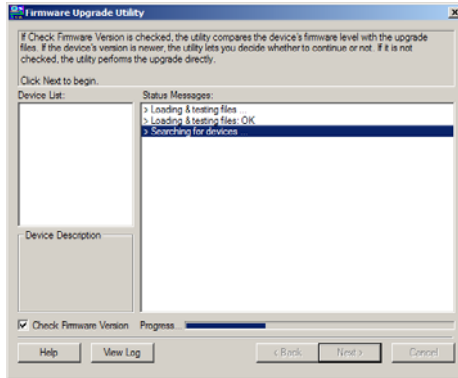

The devices capable of being upgraded by the package are listed in the *Device List* panel.

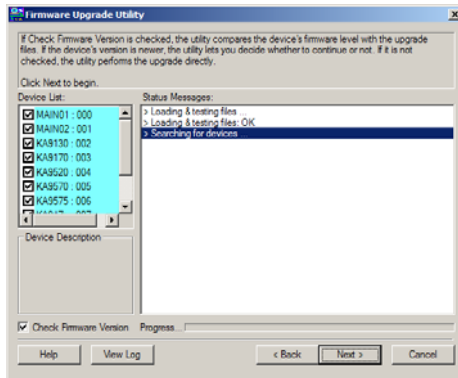

- ◆ A light blue background behind the device name indicates that it is ready to be upgraded.
7. All devices capable of being upgraded by the package are checkmarked by default, meaning an upgrade will be performed on the device. Deselect the check box next to the devices in the list that you do not want to perform an upgrade on.
  8. Click **Next** to start the upgrade.

If you enabled *Check Firmware Upgrade*, the Utility compares the device's firmware level with that of the upgrade files. If it finds that the device's version is the same, or higher, it brings up a dialog box informing you of the situation and gives you the option to Continue or Cancel.

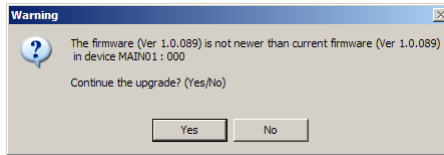

If you didn't enable *Check Firmware Upgrade*, the Utility installs the upgrade files without checking their version level.

- ◆ While a device group is being upgraded, the background behind its name changes to blue and blinks on and off to indicate that upgrading is in progress.
- ◆ A green background behind the device name indicates that it will be upgraded.
- ◆ As the Upgrade proceeds, status messages appear in the *Status Messages* panel, and the progress toward completion is shown on the *Progress* bar.

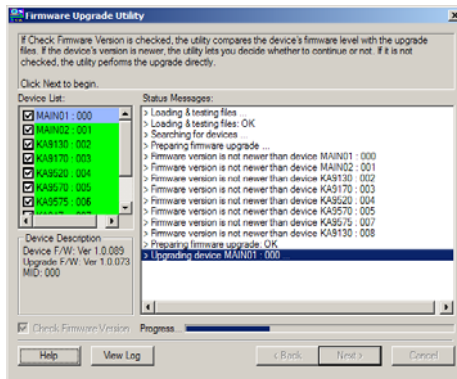

- ◆ The KH2508 / KH2516 OSD also displays the progress toward completion in its own progress bar.

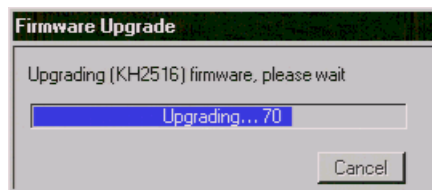

- ◆ As each device update completes, its status is reported in the *Status Messages* panel.
- ◆ When a device group upgrade is successful, the background behind the device group name changes to pink; if a member of a device group fails to upgrade successfully, the background behind the device group name changes to red to indicate that there was an upgrade failure in the group. Check the Status Messages to ascertain which device failed to upgrade.

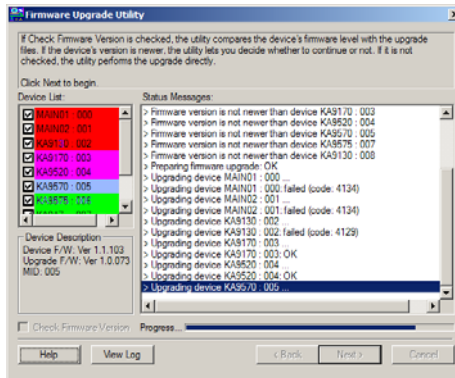

- ◆ If a device upgrade fails, you have the option of trying to upgrade the device again.

---

**Note:** You have the option of upgrading devices again only after the Firmware Upgrade Utility has attempted to upgrade all checkmarked devices in the device list.

---

Click **Yes** to attempt another upgrade, or click **No** to finish upgrading the devices.

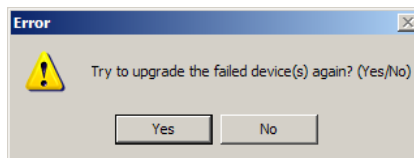



## Upgrade Successful

When all devices have been upgraded, or you decide not to try and upgrade any devices again, click **Finish** to close the Firmware Upgrade Utility.

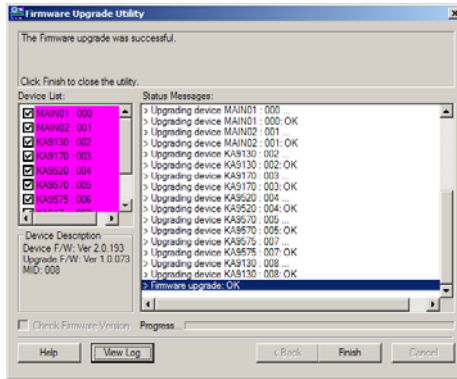

The KH2508 / KH2516 then broadcasts the firmware upgrade to all cascaded switches and KVM adapter cables in the installation. The OSD displays the progress toward completion.

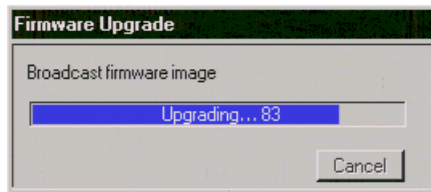

After broadcasting has completed, the KH2508 / KH2516 automatically performs a reboot on every switch in the installation.

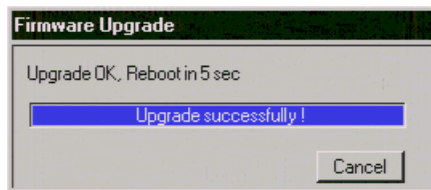

## Stopping the Firmware Upgrade

---

Stopping the Firmware Upgrade Utility before it finishes upgrading all the devices is not recommended. However, if you need to stop the Firmware Upgrade Utility while it is upgrading a device, simply click the close button in the top-right corner of the Firmware Upgrade Utility window. The following message appears:

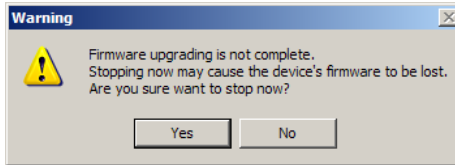

Click **Yes** to stop the Firmware Upgrade Utility, or click **No** to allow the utility to finish the upgrade.

---

**Note:** Stopping the firmware upgrade procedure may cause a switch to become inoperable, and incapable of accepting a normal firmware upgrade. If this happens, perform a Firmware Upgrade Recovery (see page 65).

---

## Upgrading Adapter Cables

---

KVM adapter cable firmware upgrades are performed on all adapter cables in an installation when upgrading the first-level KH2508 / KH2516. However, if an adapter cable on a cascaded switch fails to upgrade, we recommend using the following procedure to manually upgrade the adapter cable individually.

1. Remove the adapter cable from the cascaded switch and connect it to any KVM port on the first-level KH2508 / KH2516. (You may have to temporarily disconnect another switch/computer from the KH2508 / KH2516 if all the KVM ports are in use.) Make note of the port number you connected the adapter cable to.
2. Access the first-level KH2508 / KH2516 OSD controls and perform an adapter cable upgrade on the port with the relocated KVM adapter cable (see *Adapter Cable*, page 47).
3. After a successful firmware upgrade to the adapter cable, reconnect it to its original KVM port on the cascaded switch and reconnect the disconnected first-level switch/computer to its original KVM port.

## Upgrade Failed

---

If a device fails to complete the upgrade successfully, start the firmware upgrade procedure again. If the KH2508 / KH2516 becomes inoperable after a failed firmware upgrade, follow the Firmware Upgrade Recovery procedure below.

## Firmware Upgrade Recovery

---

If the firmware upgrade procedure is unnaturally aborted (due to a power outage, for example), the KH2508 / KH2516 that was being upgraded at the time may become inoperable, and may be incapable of accepting a normal firmware upgrade. If this occurs to the first level KH2508 / KH2516, do the following:

---

**Note:** To perform a firmware upgrade recovery on a cascaded KH2508 / KH2516, remove the switch from the installation before performing the following steps.

---

1. Prepare the Firmware Upgrade Package (see page 58).
2. Slide the unit's *Firmware Upgrade Recovery Switch* (see page 7) to the RECOVER position.
3. Perform a warm reset (see *Reset Button*, page 7).

The switch is now ready to be upgraded.

---

**Note:** When the switch is in *Firmware Upgrade Recovery Mode*, the front panel console LEDs alternately flash on and off, and the port LEDs turn on and off, scrolling from left to right, first green then red.

---

4. Run the downloaded Firmware Upgrade Package file again.
5. When all devices have been upgraded, click **Finish** to close the Firmware Upgrade Utility.
6. Slide the unit's *Firmware Upgrade Recovery Switch* (see page 7), to the NORMAL position.
7. Reboot the upgraded KH2508 / KH2516 by turning it off, then on again.

---

**Note:** After upgrading a cascaded switch, turn off the switch, return it to the installation, reconnect all cabling and turn it on.

---

This Page Intentionally Left Blank









# Chapter 6

## Keyboard Emulation

### Mac Keyboard

---

The PC compatible (101/104 key) keyboard can emulate the functions of the Mac keyboard. The emulation mappings are listed in the table below.

PC Keyboard	Mac Keyboard
[Shift]	Shift
[Ctrl]	Ctrl
	
[Ctrl] [1]	
[Ctrl] [2]	
[Ctrl] [3]	
[Ctrl] [4]	
[Alt]	Alt
[Print Screen]	F13
[Scroll Lock]	F14
	=
[Enter]	Return
[Backspace]	Delete
[Insert]	Help
[Ctrl] 	F15







---

**Note:** When using key combinations, press and release the first key (Ctrl), then press and release the activation key.

---

## Sun Keyboard

The PC compatible (101/104 key) keyboard can emulate the functions of the Sun keyboard when the Control key [Ctrl] is used in conjunction with other keys. The corresponding functions are shown in the table below.

PC Keyboard	Sun Keyboard
[Ctrl] [T]	Stop
[Ctrl] [F2]	Again
[Ctrl] [F3]	Props
[Ctrl] [F4]	Undo
[Ctrl] [F5]	Front
[Ctrl] [F6]	Copy
[Ctrl] [F7]	Open
[Ctrl] [F8]	Paste
[Ctrl] [F9]	Find
[Ctrl] [F10]	Cut
[Ctrl] [1]	
[Ctrl] [2]	
[Ctrl] [3]	
[Ctrl] [4]	
[Ctrl] [H]	Help
	Compose
	

**Note:** When using key combinations, press and release the first key (Ctrl), then press and release the activation key.

## Safety Instructions

---

### General

- ◆ Read all of these instructions. Save them for future reference.
- ◆ Follow all warnings and instructions marked on the device.
- ◆ Do not place the device on any unstable surface (cart, stand, table, etc.). If the device falls, serious damage will result.
- ◆ Do not use the device near water.
- ◆ Do not place the device near, or over, radiators or heat registers.
- ◆ The device cabinet is provided with slots and openings to allow for adequate ventilation. To ensure reliable operation, and to protect against overheating, these openings must never be blocked or covered.
- ◆ The device should never be placed on a soft surface (bed, sofa, rug, etc.) as this will block its ventilation openings. Likewise, the device should not be placed in a built in enclosure unless adequate ventilation has been provided.
- ◆ Never spill liquid of any kind on the device.
- ◆ Unplug the device from the wall outlet before cleaning. Do not use liquid or aerosol cleaners. Use a damp cloth for cleaning.
- ◆ The device should be operated from the type of power source indicated on the marking label. If you are not sure of the type of power available, consult your dealer or local power company.
- ◆ The device is designed for IT power distribution systems with 230V phase-to-phase voltage.
- ◆ To prevent damage to your installation it is important that all devices are properly grounded.
- ◆ The device is equipped with a 3-wire grounding type plug. This is a safety feature. If you are unable to insert the plug into the outlet, contact your electrician to replace your obsolete outlet. Do not attempt to defeat the purpose of the grounding-type plug. Always follow your local/national wiring codes.
- ◆ Do not allow anything to rest on the power cord or cables. Route the power cord and cables so that they cannot be stepped on or tripped over.

- ◆ If an extension cord is used with this device make sure that the total of the ampere ratings of all products used on this cord does not exceed the extension cord ampere rating. Make sure that the total of all products plugged into the wall outlet does not exceed 15 amperes.
- ◆ To help protect your system from sudden, transient increases and decreases in electrical power, use a surge suppressor, line conditioner, or uninterruptible power supply (UPS).
- ◆ Position system cables and power cables carefully; Be sure that nothing rests on any cables.
- ◆ Never push objects of any kind into or through cabinet slots. They may touch dangerous voltage points or short out parts resulting in a risk of fire or electrical shock.
- ◆ Do not attempt to service the device yourself. Refer all servicing to qualified service personnel.
- ◆ If the following conditions occur, unplug the device from the wall outlet and bring it to qualified service personnel for repair.
  - ◆ The power cord or plug has become damaged or frayed.
  - ◆ Liquid has been spilled into the device.
  - ◆ The device has been exposed to rain or water.
  - ◆ The device has been dropped, or the cabinet has been damaged.
  - ◆ The device exhibits a distinct change in performance, indicating a need for service.
  - ◆ The device does not operate normally when the operating instructions are followed.
- ◆ Only adjust those controls that are covered in the operating instructions. Improper adjustment of other controls may result in damage that will require extensive work by a qualified technician to repair.
- ◆ Do not connect the RJ-11 connector marked “UPGRADE” to a public telecommunication network.



---

## **Rack Mounting**

- ◆ Before working on the rack, make sure that the stabilizers are secured to the rack, extended to the floor, and that the full weight of the rack rests on the floor. Install front and side stabilizers on a single rack or front stabilizers for joined multiple racks before working on the rack.
- ◆ Always load the rack from the bottom up, and load the heaviest item in the rack first.
- ◆ Make sure that the rack is level and stable before extending a device from the rack.
- ◆ Use caution when pressing the device rail release latches and sliding a device into or out of a rack; the slide rails can pinch your fingers.
- ◆ After a device is inserted into the rack, carefully extend the rail into a locking position, and then slide the device into the rack.
- ◆ Do not overload the AC supply branch circuit that provides power to the rack. The total rack load should not exceed 80 percent of the branch circuit rating.
- ◆ Make sure that all equipment used on the rack – including power strips and other electrical connectors – is properly grounded.
- ◆ Ensure that proper airflow is provided to devices in the rack.
- ◆ Ensure that the operating ambient temperature of the rack environment does not exceed the maximum ambient temperature specified for the equipment by the manufacturer
- ◆ Do not step on or stand on any device when servicing other devices in a rack.

## Technical Support

Technical support is available both by email and online (with a browser over the web):

### International

Email Support		support@aten.com
Online Support	Technical Support	http://support.aten.com
	Troubleshooting Documentation Software Updates	http://www.aten.com
Telephone Support		886-2-8692-6959

### North America

Email Support		ATEN TECH	support@aten-usa.com
		ATEN NJ	sales@aten.com
Online Support	Technical Support	ATEN TECH	http://www.aten-usa.com/support
		ATEN NJ	http://support.aten.com
	Troubleshooting Documentation Software Updates	ATEN TECH	http://www.aten-usa.com
		ATEN NJ	http://www.aten.com
Telephone Support		ATEN TECH	1-888-999-ATEN
		ATEN NJ	1-732-356-1703

When you contact us, please have the following information ready beforehand:

- ◆ Product model number, serial number, and date of purchase.
- ◆ Your computer configuration, including operating system, revision level, expansion cards, and software.
- ◆ Any error messages displayed at the time the error occurred.
- ◆ The sequence of operations that led up to the error.
- ◆ Any other information you feel may be of help.

# Specifications

Function		KH2508	KH2516	
Computer Connections	Direct	8	16	
	Max	512 (via Cascade)	4096 (via Cascade)	
Port Selection		OSD		
Connectors	Console Ports	Keyboard	2 x 6-pin Mini-DIN Female (Purple); 2 x USB Type A Female	
		Video	2 x HDB-15 Female (Blue)	
		Mouse	2 x 6-pin Mini-DIN Female (Green); 2 x USB Type A Female	
		USB	2 x USB Type A Female	
	KVM Ports		8 x RJ-45 Female	16 x RJ-45 Female
	Cascade Ports		2 x RJ-45 Female	
	FW Upgrade		1 x RJ-11 Female (Black)	
	Power		1 x 3-prong AC socket	
Switches	Reset	1 x Semi-recessed pushbutton		
	Power	1 x Rocker		
	F/W Upgrade	1 x Slide		
LEDs	Online	8 (Green)	16 (Green)	
	Selected	8 (Orange)	16 (Orange)	
	Power	1 (Blue)		
	Cascade	2 (Green)		
Emulation	Keyboard / Mouse	PS/2; USB (PC, Mac, Sun)		
Video		1280 x 1024 @ 75 Hz (40 m max.) 1600 x 1200 @ 60 Hz (30 m max.) DDC2B		
Scan Interval (OSD Select)		1–255 sec.		
I/P Rating		100–240 V AC; 50/60 Hz; 1 A		
Power Consumption		120 / 230 V; 28 W	120 / 230 V; 30 W	
Environment	Operating Temp.	0–50° C		
	Storage Temp.	-20–60° C		
	Humidity	0–80% RH; Noncondensing		
Physical Properties	Housing	Metal / Plastic		
	Weight	3.68 kg	3.74 kg	
	Dimensions (L x W x H)	43.36 x 28.78 x 4.40 cm (19" / 1U)		

## OSD Factory Default Settings

---

The factory default settings are as follows:

<b>Setting</b>	<b>Default</b>
OSD Hotkey	[Scroll Lock] [Scroll Lock]
Port ID Display Mode	Port Number + Name
Port ID Display Duration	5 Seconds
Scan Target	All
Scan Duration	10 Seconds
Screen Blanker	0 min. (Disabled)
Logout Timeout	30 min.
Beeper	On
Device Name	KH2508 / KH2516
Configuration File Name	KH2508.BIN / KH2516.BIN
Port Cable Length	Short
Port OS/Platform	PC (Serial)
Port Language	English
Port Operation Mode	Share

# Troubleshooting

## Overview

Operation problems can be due to a variety of causes. The first step in solving them is to make sure that all cables are securely attached and seated completely in their sockets.

In addition, updating the product's firmware may solve problems that have been discovered and resolved since the prior version was released. If your product is not running the latest firmware version, we strongly recommend that you upgrade. See *The Firmware Upgrade Utility*, page 57, for upgrade details.

## General

Problem	Solution
The KVM console monitor does not display and there is no response to keyboard and mouse input.	<ol style="list-style-type: none"> <li>1. Verify that all cables are securely connected and in good condition, including those of the console modules.</li> <li>2. Upgrade the firmware for the KVM adapter cables.</li> </ol>
The password for the default administrator account needs to be reset.	See <i>Restoring Original Factory Default Settings</i> , page 78.
I upgraded the firmware, but some of the modules were not upgraded successfully.	See <i>Upgrade Failed</i> , page 65.
The firmware upgrade process was prematurely aborted and now some of the modules are inoperable.	See <i>Upgrade Failed</i> , page 65.
I can't upgrade the firmware version.	Make sure that you have selected the correct firmware upgrade package and try again (see <i>The Firmware Upgrade Utility</i> , page 57).
I can't access the KH2508 / KH2516 through the OSD.	<ol style="list-style-type: none"> <li>1. Perform a system reset (see <i>Reset Button</i>, page 7).</li> <li>2. Reinstall the firmware (see <i>The Firmware Upgrade Utility</i>, page 57).</li> </ol>

(Continues on next page.)

(Continued from previous page.)

Problem	Solution
<p>Some characters I enter from the keyboard do not display correctly.</p>	<p>The keyboard layout setting for the port does not match the keyboard you are using. Change the keyboard layout setting for the port to match the layout of the keyboard you are using.</p> <p>To change the keyboard layout setting:</p> <ol style="list-style-type: none"> <li>1. Log in to the OSD from a local console (see page 27) and click the <i>Administration</i> tab.</li> <li>2. Click the icon to switch to the <i>System</i> dialog box (see page 46).</li> <li>3. In the <i>Adapter Cables</i> section, click <b>Attributes</b>.</li> <li>4. In the <i>Keyboard Layout</i> field, select the layout of the keyboard you want to use (see page 52).</li> <li>5. Click <b>OK</b>.</li> <li>6. If the computer attached to the port is a Sun server or iMac, or if changing the keyboard layout setting doesn't immediately resolve the problem, reboot the computer. After rebooting, the characters you enter from the keyboard should display properly.</li> </ol>
<p>I can't use the special keys on my Apple (Sun) keyboard to control Mac (Sun) computers.</p>	<p>The keyboard setting for the port in which you are having the problem does not match the keyboard that you are using.</p> <p>In order to use the special keys on Apple (Sun) keyboards to control Mac (Sun) computers, the keyboard setting for the port must match the keyboard you are using.</p> <p>See solution above.</p>

## Sun Systems

Problem	Solution
Video display problems with HDB-15 interface systems (e.g. Sun Blade 1000 servers).	<p>The display resolution should be set to 1024 x 768 @ 60Hz.</p> <p>Under Text Mode:</p> <ol style="list-style-type: none"> <li>1. Enter the <code>ok</code> prompt (see page 79) and issue the following firmware commands:</li> </ol> <pre>setenv output-device screen:r1024x768x60 reset-all</pre> <p>Under XWindow:</p> <ol style="list-style-type: none"> <li>1. Open a console and issue the following command:</li> </ol> <pre>m64config -res 1024x768x60</pre> <ol style="list-style-type: none"> <li>2. Log out.</li> <li>3. Log in.</li> </ol>
Video display problems with 13W3 interface systems (e.g. Sun Ultra servers).*	<p>The display resolution should be set to 1024 x 768 @ 60Hz.</p> <p>Under Text Mode:</p> <ol style="list-style-type: none"> <li>1. Enter the <code>ok</code> prompt (see page 79) and issue the following firmware commands:</li> </ol> <pre>setenv output-device screen:r1024x768x60 reset-all</pre> <p>Under XWindow:</p> <ol style="list-style-type: none"> <li>1. Open a console and issue the following command:</li> </ol> <pre>fbconfig -res 1024x768x60</pre> <ol style="list-style-type: none"> <li>2. Log out.</li> <li>3. Log in.</li> </ol>

\* These solutions work for most common Sun VGA cards. If these procedures fail to resolve the problem, consult the manual for the Sun VGA card.

## Restoring Original Factory Default Settings

---

You can restore the original factory default settings for the KH2508 / KH2516 Cat 5 KVM Switch. The original password for the default administrator account is restored; all administrator and user accounts are removed from the system. Only the station name and date and time are retained. This procedure requires the use of a jumper cap.

1. Turn off the KH2508 / KH2516 and unplug the power cord.
2. Remove the cover of the KH2508 / KH2516.
3. Place a jumper cap over pins 1-2 of the J11 jumper on the mainboard.

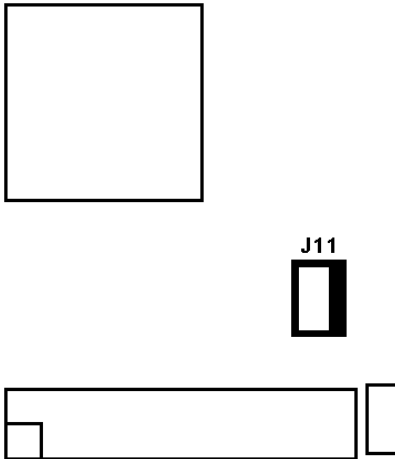

4. Plug in the power cord and turn on the KH2508 / KH2516. The following directions appear on the console screen:

```
USERNAME AND PASSWORD INFORMATION AND PORT/USER  
INFORMATION HAS BEEN CLEARED. PLEASE POWER OFF THE  
SWITCH, REMOVE THE JUMPER, CLOSE THE CASE, THEN  
RESTART.
```

5. Turn off the KH2508 / KH2516 and unplug the power cord.
6. Remove the jumper cap from pins 1-2 of the J11 jumper.
7. Replace the cover on the KH2508 / KH2516. Plug in the power cord and turn on the KH2508 / KH2516.
8. You should now use the default username and password to login to the OSD.



## Entering the `ok` Prompt (Sun Solaris)

---

If you are using a PC keyboard to control a Sun Solaris server and want to use Stop-A keys to enter the `ok` prompt, do the following:

---

**Note:** Before entering the `ok` prompt, consult the server's documentation for any precautionary steps that you should take.

---

Press and release **[Ctrl]**, press and hold down **[T]**, and then press **[A]**.

## Supported KVM Switches

---

The following is a list of supported KVM switches that can be cascaded from the KH2508 / KH2516.

- ◆ KH2508
- ◆ KH2516

## Limited Warranty

---

ALTUSEN warrants this product against defects in material or workmanship for a period of one (1) year from the date of purchase. If this product proves to be defective, contact ALTUSEN's support department for repair or replacement of your unit. ALTUSEN will not issue a refund. Return requests can not be processed without the original proof of purchase.

When returning the product, you must ship the product in its original packaging or packaging that gives an equal degree of protection. Include your proof of purchase in the packaging and the RMA number clearly marked on the outside of the package.

This warranty becomes invalid if the factory-supplied serial number has been removed or altered on the product.

This warranty does not cover cosmetic damage or damage due to acts of God, accident, misuse, abuse, negligence or modification of any part of the product. This warranty does not cover damage due to improper operation or maintenance, connection to improper equipment, or attempted repair by anyone other than ALTUSEN. This warranty does not cover products sold AS IS or WITH FAULTS.

IN NO EVENT SHALL ALTUSEN'S LIABILITY EXCEED THE PRICE PAID FOR THE PRODUCT. FURTHER, ALTUSEN SHALL NOT BE RESPONSIBLE FOR DIRECT, INDIRECT, SPECIAL, INCIDENTAL OR CONSEQUENTIAL DAMAGES RESULTING FROM THE USE OF THE PRODUCT, ITS ACCOMPANYING SOFTWARE, OR ITS DOCUMENTATION. ALTUSEN SHALL NOT IN ANY WAY BE RESPONSIBLE FOR, WITHOUT LIMITATION, LOSS OF DATA, LOSS OF PROFITS, DOWNTIME, GOODWILL, DAMAGE OR REPLACEMENT OF EQUIPMENT OR PROPERTY, AND ANY EXPENSES FROM RECOVERY, PROGRAMMING, AND REPRODUCTION OF ANY PROGRAM OR DATA.

ALTUSEN makes no warranty or representation, expressed, implied, or statutory with respect to its products, contents or use of this documentation and all accompanying software, and specifically disclaims its quality, performance, merchantability, or fitness for any particular purpose.

ALTUSEN reserves the right to revise or update its product, software or documentation without obligation to notify any individual or entity of such revisions, or update.

For details about extended warranties, please contact one of our dedicated value added resellers.

## A

- Adapter cable installation, 19
- Administration
  - Configuration Page, 40
  - List Function, 31
  - Log Page, 56
  - Main Page, 29
  - Quick View Ports, 30
- Administration Page, 42
- Auto Scanning, 39
  - Exiting, 39
  - Invoking, 39
  - Pausing, 39
  - Scan Interval, 39

## C

- cables, 5
- Changing an Attribute, 53
- Configuration Page, 40
- console modules, 11

## D

- Date/Time, 55
- desktop mounting, 12

## F

- Factory Default Settings, 74
- factory default settings
  - restoring, 78
- Firmware
  - upgrading, 56
- Firmware upgrade
  - utility, 57

## G

- Grounding, 16

## H

- hot plugging, 25
- Hotkey Operation, 38

## I

- Installation
  - Multilevel, 20
- installation
  - overview, 11
  - single level, 17

## K

- Keyboard Emulation
  - Mac, 67
  - Sun, 68
- KH2508/KH2516
  - desktop mounting, 12
  - front view, 6
  - rack mounting, 12
  - rear view, 8
  - stacking, 12
- KVM adapter cables, 4, 8, 11
- KVM adapter installation, 19

## L

- List Function, 31
- Log Page, 56
- Login Failures, 46

## M

- mounting
  - desktop, 12

## O

- Online
  - Registration, iii
- OSD
  - Factory Default Settings, 74
  - overview, 27

## P

- Port Names, 33
- ports
  - selection, 25
- powering off, 25

## Q

- Quick View Ports, 30

## R

- rack mounting, 12
  - front, 13
  - rear, 15
- restarting, 25
- restoring
  - factory default settings, 78
- RoHS, ii

## S

- Safety Instructions
  - General, 69
  - Rack Mounting, 71
- Share Mode Attribute Table, 53
- SJ/T 11364-2006, ii
- Skip Mode, 40
- Specifications, 73
- stacking, 12
- system requirements
  - cables, 5
  - computers, 4
  - consoles, 4
  - operating systems, 5

## T

- Technical Support, 72
- Telephone support, iii
- Toolbar Icons, 37

## U

- Upgrading the Firmware, 56
- User Management, 43
- User Notice, iii

## W

- Windows Client
  - Auto Scanning, 39
  - Hotkey Operation, 38
  - Toolbar Icons, 37